

Dyalog Programming Reference Guide

Dyalog version **17.1**

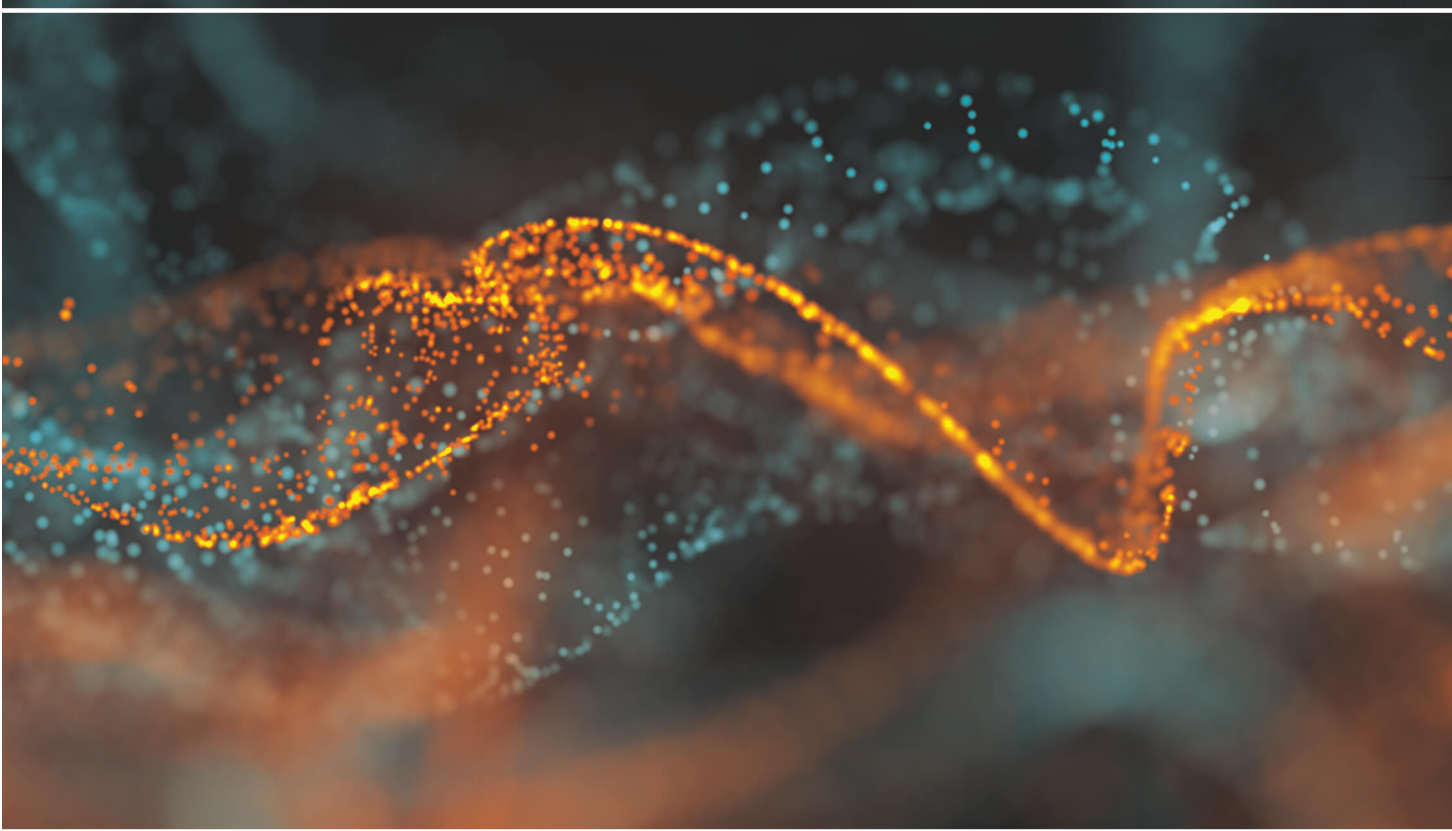

DYALOG

The tool of thought for software solutions

*Dyalog is a trademark of Dyalog Limited
Copyright © 1982-2019 by Dyalog Limited
All rights reserved.*

Dyalog Programming Reference Guide

Dyalog version 17.1
Document Revision: 20240212_171

Unless stated otherwise, all examples in this document assume that `IO ML ← 1`

No part of this publication may be reproduced in any form by any means without the prior written permission of Dyalog Limited.

Dyalog Limited makes no representations or warranties with respect to the contents hereof and specifically disclaims any implied warranties of merchantability or fitness for any particular purpose. Dyalog Limited reserves the right to revise this publication without notification.

*email: support@dyalog.com
<https://www.dyalog.com>*

TRADEMARKS:

SQAPL is copyright of Insight Systems ApS.

Array Editor is copyright of davidliebtag.com

Raspberry Pi is a trademark of the Raspberry Pi Foundation.

Oracle®, Javascript™ and Java™ are registered trademarks of Oracle and/or its affiliates.

UNIX® is a registered trademark in the United States and other countries, licensed exclusively through X/Open Company Limited.

Linux® is the registered trademark of Linus Torvalds in the U.S. and other countries.

Windows® is a registered trademark of Microsoft Corporation in the United States and other countries.

macOS® and OS X® (operating system software) are trademarks of Apple Inc., registered in the U.S. and other countries.

All other trademarks and copyrights are acknowledged.

Contents

Chapter 1: Introduction	1
Workspaces	1
Arrays	2
Legal Names	6
Specification of Variables	6
Vector Notation	7
Structuring of Arrays	8
Display of Arrays	9
Prototypes and Fill Items	15
Cells and Sub-arrays	16
Expressions	18
Functions	19
Operators	22
Binding Strength	24
Function Trains	26
Parallel Execution	30
Complex Numbers	31
128 Bit Decimal Floating-Point Support	35
Namespaces	40
Threads	59
External Variables	73
Component Files	74
Auxiliary Processors	74
Key to Notation	75
Migration Level	75
Chapter 2: Defined Functions & Operators	77
Canonical Representation	77
Model Syntax	78
Statements	79
Global & Local Names	80
Locals Lines	82
Namelists	83
Function Declaration Statements	84
Access Statement	85
Attribute Statement	86
Implements Statement	87
Signature Statement	88
Control Structures	90
Access Statement	93

Attribute Statement	93
If Statement	94
While Statement	97
Repeat Statement	99
For Statement	101
Select Statement	103
With Statement	105
Hold Statement	106
Trap Statement	110
GoTo Statement	113
Return Statement	113
Leave Statement	113
Continue Statement	114
Section Statement	114
Disposable Statement	114
Triggers	117
Idiom Recognition	122
Search Functions and Hash Tables	129
Locked Functions & Operators	130
The State Indicator	131
Dfns & Dops	133
APL Line Editor	148
Chapter 3: Object Oriented Programming	157
Introducing Classes	157
Constructors	163
Destructors	176
Class Members	179
Fields	180
Methods	185
Properties	189
Interfaces	202
Including Namespaces in Classes	205
Nested Classes	207
Namespace Scripts	216
Including Script Files in Scripts	222
Class Declaration Statements	223
:Property Section	232
PropertyGet Function	234
PropertySet Function	235
PropertyShape Function	236
Chapter 4: APL Files	237
Introduction	237
Component Files	238
Programming Techniques	246

File Design	249
Internal Structure	249
The Effect of Buffering	252
Integrity and Security	253
Chapter 5: Error Trapping	255
Standard Error Action	255
Error Trapping Concepts	256
Example Traps	260
Signalling Events	267
Handling Unexpected Application Errors in Windows	269
Chapter 6: Error Messages	271
Introduction	271
APL Errors	272
Operating System Error Messages	275
Windows Operating System Error Messages	277
APL Error Messages	278
bad ws	278
cannot create name	278
clear ws	278
copy incomplete	278
DEADLOCK	278
defn error	279
DOMAIN ERROR	280
EOF INTERRUPT	280
EXCEPTION	280
FIELD CONTENTS RANK ERROR	281
FIELD CONTENTS TOO MANY COLUMNS	281
FIELD POSITION ERROR	281
FIELD CONTENTS TYPE MISMATCH	281
FIELD TYPE BEHAVIOUR UNRECOGNISED	281
FIELD ATTRIBUTES RANK ERROR	281
FIELD ATTRIBUTES LENGTH ERROR	281
FULL SCREEN ERROR	281
KEY CODE UNRECOGNISED	282
KEY CODE RANK ERROR	282
KEY CODE TYPE ERROR	282
FORMAT FILE ACCESS ERROR	282
FORMAT FILE ERROR	282
FILE ACCESS ERROR	283
FILE ACCESS ERROR CONVERTING	283
FILE COMPONENT DAMAGED	283
FILE DAMAGED	284
FILE FULL	284
FILE INDEX ERROR	284

FILE NAME ERROR	284
FILE NAME QUOTA USED UP	285
FILE SYSTEM ERROR	285
FILE SYSTEM NO SPACE	285
FILE SYSTEM NOT AVAILABLE	285
FILE SYSTEM TIES USED UP	285
FILE TIE ERROR	286
FILE TIED	286
FILE TIED REMOTELY	286
FILE TIE QUOTA USED UP	287
FORMAT ERROR	287
HOLD ERROR	287
incorrect command	288
INDEX ERROR	288
INTERNAL ERROR	289
INTERRUPT	289
is name	289
LENGTH ERROR	290
LIMIT ERROR	290
NONCE ERROR	290
NO PIPES	290
name is not a ws	291
Name already exists	291
Namespace does not exist	291
not copied name	292
not found name	292
not saved this ws is name	292
PROCESSOR TABLE FULL	293
RANK ERROR	294
RESIZE	294
name saved date time	294
SYNTAX ERROR	295
sys error number	296
TIMEOUT	296
TRANSLATION ERROR	296
TRAP ERROR	296
too many names	297
VALUE ERROR	297
warning duplicate label	297
warning duplicate name	298
warning pendent operation	298
warning label name present	298
warning unmatched brackets	299
warning unmatched parentheses	299
was name	299
WS FULL	300
ws not found	300
ws too large	300

Operating System Error Messages	301
FILE ERROR 1 Not owner	301
FILE ERROR 2 No such file	301
FILE ERROR 5 IO error	301
FILE ERROR 6 No such device	301
FILE ERROR 13 Permission denied	301
FILE ERROR 20 Not a directory	301
FILE ERROR 21 Is a directory	302
FILE ERROR 23 File table overflow	302
FILE ERROR 24 Too many open	302
FILE ERROR 26 Text file busy	302
FILE ERROR 27 File too large	302
FILE ERROR 28 No space left	302
FILE ERROR 30 Read only file	303
System Errors	304
Symbolic Index	313
Index	323

Chapter 1:

Introduction

Workspaces

APL expressions are evaluated within a workspace. The workspace may contain objects, namely classes, namespaces, operators, functions and variables defined by the user. APL expressions may include references to primitive operators, functions and variables provided by APL. These objects do not reside in the workspace, but space is required for the actual process of evaluation to accommodate temporary data. During execution, APL records the state of execution through the STATE INDICATOR which is dynamically maintained until the process is complete. Space is also required to identify objects in the workspace in the SYMBOL TABLE. Maintenance of the symbol table is entirely dynamic. It grows and contracts according to the current workspace contents.

Workspaces may be explicitly saved with an identifying name. The workspace may subsequently be loaded, or objects may be selectively copied from a saved workspace into the current workspace.

Under UNIX, workspace names must be valid file names, but are otherwise unrestricted. See your UNIX documentation for details.

Under Windows, Dyalog APL workspaces are stored in files with the suffix ".DWS". However, they are referred to from within APL by only the first part of the file name which must conform to Windows file naming rules.

If the name of the file in which the workspace is saved contains spaces, the ws argument for the system functions `)SAVE`, `)COPY`, `)PCOPY`, `)LOAD`, `)XLOAD` and `)DROP` should be surrounded by two double-quote (") characters. To include a " character in the file name, you must specify two adjoining double-quotes (i.e. """). Note however that Windows does not allow double-quotes in file names, so this effectively applies only to non-Windows systems.

Examples

```
)SAVE Pete's work
unacceptable char
```

The above statement fails because the presence of the space in the file name requires that it be surrounded by "s.

```
)SAVE "Pete's work"
Pete's work.dws saved Sun Jan 17 16:23:17 2016
```

```
)COPY "Pete's work" A B C
.\Pete's work.dws saved Sun Jan 17 16:23:17 2016
```

```
)DROP "Pete's work"
Sun Jan 17 16:24:16 2016
```

Arrays

A Dyalog APL data structure is called an array. An array is a rectangular arrangement of items, each of which may be a single number, a single character, a namespace reference (ref), another array, or the `⌈OR` of an object. An array which is part of another array is also known as a subarray.

An array has two properties; structure and data type. Structure is identified by rank, shape, and depth.

Rank

An array may have 0 or more axes or dimensions. The number of axes of an array is known as its rank. Dyalog APL supports arrays with a maximum of 15 axes.

- An array with 0 axes (rank 0) is called a scalar.
- An array with 1 axis (rank 1) is called a vector.
- An array with 2 axes (rank 2) is called a matrix.
- An array with more than 2 axes is called a multi-dimensional array.

Shape

Each axis of an array may contain zero or more items. The number of items along each axis of an array is called its shape. The shape of an array is itself a vector. Its first item is the length of the first axis, its second item the length of the second axis, and so on. An array, whose length along one or more axes is zero, is called an empty array.

Depth

An array whose items are all simple scalars (i.e. single numbers, characters or refs) is called a simple array. If one or more items of an array is not a simple scalar (i.e. is another array, or a `REF`), the array is called a nested array. A nested array may contain items which are themselves nested arrays. The degree of nesting of an array is called its depth. A simple scalar has a depth of 0. A simple vector, matrix, or multi-dimensional array has depth 1. An array whose items are all depth 1 subarrays has depth 2; one whose items are all depth 2 subarrays has depth 3, and so forth.

Type

An array, whose elements are all numeric, is called a numeric array; its TYPE is numeric. A character array is one in which all items are characters. An array whose items contain both numeric and character elements is of MIXED type.

Numbers

Dyalog APL supports both real numbers and complex numbers.

Real Numbers

Numbers are entered or displayed using conventional decimal notation (e.g. 299792.458) or using a scaled form (e.g. 2.999792458E5).

On entry, a decimal point is optional if there is no fractional part. On output, a number with no fractional part (an integer) is displayed without a decimal point.

The scaled form consists of:

- a. an integer or decimal number called the mantissa,
- b. the letter `E` or `e`,
- c. an integer called the scale, or exponent.

The scale specifies the power of 10 by which the mantissa is to be multiplied.

Example

```

      12 23.24 23.0 2.145E2
12 23.24 23 214.5

```

Negative numbers are preceded by the high minus (`⎵`) symbol, not to be confused with the minus (`-`) function. In scaled form, both the mantissa and the scale may be negative.

Example

```

      -22 2.145E-2 -10.25
-22 0.02145 -10.25

```

Complex Numbers

Complex numbers use the J notation introduced in IBM APL2 and are written as **aJb** or **ajb** (without spaces) where the real and imaginary parts **a** and **b** are written as described above. The capital **J** is always used to display a value.

Examples

```

      2+-1*.5
2J1
      .3j.5
0.3J0.5
      1.2E5J-4E-4
120000J-0.0004

```

The empty vector (**⍋0**) may be represented by the numeric constant **⍋** called ZILDE.

Characters

Characters are entered within a pair of APL quotes. The surrounding APL quotes are not displayed on output. The APL quote character itself must be entered as a pair of APL quotes.

Examples

```

      'DIALOG APL'
DIALOG APL

      'I DON'T KNOW'
I DON'T KNOW

      '* '
*

```

Enclosed Elements

An array may be enclosed to form a scalar element through any of the following means:

- by the enclose function (`c`)
- by inclusion in vector notation
- as the result of certain functions when applied to arrays

Examples

```
      (c1 2 3), c'ABC'  
1 2 3  ABC
```

```
      (1 2 3) 'ABC'  
1 2 3  ABC
```

```
      1 2 3  
1 1  1 2  1 3  
2 1  2 2  2 3
```

Legal Names

APL objects may be given names. A name may be any sequence of characters, starting with a non-numeric character, selected from the following:

```

ABCDEFGHIJKLMNOPQRSTUVWXYZ_
abcdefghijklmnopqrstuvwxyz
ÀÁÂÃÄÅÆÇÈÉÊËÌÍÎÏÐÑÒÓÔÕÖØÙÚÛÜÝß
àáâãääæçèéêëìíîïðñòóôõöøùúûüþ
0123456789
ΔΔ
ABCDEFGHIJKLMNOPQRSTUVWXYZ

```

Note that using a standard Unicode font (rather than APL385 Unicode used in the table above), the last row above would appear as the circled alphabet, (A) to (Z).

Examples

Legal	Illegal
THISΔISΔΔΔNAME	BAD NAME
X1233	3+21
SALES	S!H PRICE
pjb_1	1_pjb

Specification of Variables

A variable is a named array. An undefined name or an existing variable may be assigned an array by specification with the left arrow (\leftarrow).

Examples

```

A←'CHIPS WITH EVERYTHING'
A
CHIPS WITH EVERYTHING

X Y←'ONE' 'TWO'
X
ONE
Y
TWO

```

Vector Notation

A series of two or more adjacent expressions results in a vector whose elements are the enclosed arrays resulting from each expression. This is known as vector (or strand) notation. Each expression in the series may consist of one of the following:

- a. a single numeric value
- b. single character, within a pair of quotes
- c. more than one character, within a pair of quotes
- d. the name of a variable
- e. the evaluated input symbol `⎕`
- f. the quote-quad symbol `⎕`
- g. the name of a niladic, defined function yielding a result
- h. any other APL expression which yields a result, within parentheses

Examples

```

3      ρA←2 4 10
2      ρTEXT←'ONE' 'TWO'
```

Numbers and characters may be mixed:

```

2      ρX←'THE ANSWER IS ' 10
      X[1]
THE ANSWER IS
      X[2] + 32
42
```

Blanks, quotes or parentheses must separate adjacent items in vector notation. Redundant blanks and parentheses are permitted. In this manual, the symbol pair '`↔`' indicates the phrase 'is equivalent to'.

```

1 2 ↔ (1)(2) ↔ 1 (2) ↔ (1) 2
2 'X' 3 ↔ 2 'X' 3 ↔ (2) ('X') (3)
1 (2+2) ↔ (1) ((2+2)) ↔ ((1)) (2+2)

```

Vector notation may be used to define an item in vector notation:

```

ρX ← 1 (2 3 4) ('THIS' 'AND' 'THAT')
3
  X[2]
2 3 4
  X[3]
THIS AND THAT

```

Expressions within parentheses are evaluated to produce an item in the vector:

```

Y ← (2+2) 'IS' 4
Y
4 IS 4

```

The following identity holds:

```
A B C ↔ (←A), (←B), ←C
```

Structuring of Arrays

A class of primitive functions re-structures arrays in some way. Arrays may be input only in scalar or vector form. Structural functions may produce arrays with a higher rank. The Structural functions are reshape (ρ), ravel, laminate and catenate (\cup), reverse and rotate (ϕ), transpose (ϕ), mix and take (\uparrow), split and drop (\downarrow), enlist (ϵ), and enclose (\leftarrow).

Examples

```

2 2ρ1 2 3 4
1 2
3 4

2 2 4ρ'ABCDEFGHIJKLMNPO'
ABCD
EFGH

IJKL
MNOP

↓2 4ρ'COWSHENS'
COWS HENS

```

Display of Arrays

Simple scalars and vectors are displayed in a single line beginning at the left margin. A number is separated from the next adjacent element by a single space. The number of significant digits to be printed is determined by the system variable `PP` whose default value is 10. The fractional part of the number will be rounded in the last digit if it cannot be represented within the print precision. Trailing zeros after a decimal point and leading zeros will not be printed. An integer number will display without a decimal point.

Examples

```
      0.1 1.0 1.12
0.1 1 1.12
```

```
      'A' 2 'B' 'C'
A 2 BC
```

```
      ÷3 2 6
0.3333333333 0.5 0.1666666667
```

If a number cannot be fully represented in `PP` significant digits, or if the number requires more than five leading zeros after the decimal point, the number is represented in scaled form. The mantissa will display up to `PP` significant digits, but trailing zeros will not be displayed.

Examples

```
      PP←3
      123 1234 12345 0.12345 0.00012345 0.00000012345
123 1.23E3 1.23E4 0.123 0.000123 1.23E-7
```

Simple matrices are displayed in rectangular form, with one line per matrix row. All elements in a given column are displayed in the same format, but the format and width for each column is determined independently of other columns. A column is treated as numeric if it contains any numeric elements. The width of a numeric column is determined such that the decimal points (if any) are aligned; that the `E` characters for scaled formats are aligned, with trailing zeros added to the mantissae if necessary, and that integer forms are right-adjusted one place to the left of the decimal point column (if any). Numeric columns are right-justified; a column which contains no numeric elements is left-justified. Numeric columns are separated from their neighbours by a single column of blanks.

Examples

```

      2 4p'HANDFIST'
HAND
FIST

```

```

      1 2 3 4 5
     6 2 5
    12 4 10
    18 6 15

```

```

      2 3p2 4 6.1 8 10.24 12
     2 4      6.1
     8 10.24 12

```

```

      2 4p4 'A' 'B' 5 -0.00000003 'C' 'D' 123.56
     4E0 AB 5
    -3E-9 CD 123.56

```

In the display of non-simple arrays, each element is displayed within a rectangle such that the rows and columns of the array are aligned. Simple items within the array are displayed as above. For non-simple items, this rule is applied recursively, with one space added on each side of the enclosed element for each level of nesting.

Examples

```

      13
     1 2 3

```

```

      c13
     1 2 3

```

```

      cc13
     1 2 3

```

```

      ('ONE' 1) ('TWO' 2) ('THREE' 3) ('FOUR' 4)
     ONE 1 TWO 2 THREE 3 FOUR 4

```

```

      2 4p'ONE' 1 'TWO' 2 'THREE' 3 'FOUR' 4
     ONE 1 TWO 2
     THREE 3 FOUR 4

```

Multi-dimensional arrays are displayed in rectangular planes. Planes are separated by one blank line, and hyper-planes of higher dimensions are separated by increasing numbers of blank lines. In all other respects, multi-dimensional arrays are displayed in the same manner as matrices.

Examples

```

          2 3 4p124
1   2   3   4
5   6   7   8
9  10  11  12

13 14 15 16
17 18 19 20
21 22 23 24

          3 1 1 3p'THEREDFOX'
THE

RED

FOX

```

The power of this form of display is made apparent when formatting informal reports.

Examples

```

          +AREAS←'West' 'Central' 'East'
West   Central   East

          +PRODUCTS←'Biscuits' 'Cakes' 'Buns' 'Rolls'
Biscuits  Cakes  Buns  Rolls

          SALES←50 5.25 75 250 20.15 900 500
          SALES,←80.98 650 1000 90.03 1200
          +SALES←4 3pSALES
50  5.25  75
250 20.15  900
500 80.98  650
1000 90.03 1200

          ' ' PRODUCTS ;., AREAS SALES
          West  Central  East
Biscuits      50      5.25  75
Cakes         250     20.15  900
Buns          500     80.98  650
Rolls        1000     90.03 1200

```

If the display of an array is wider than the page width, as set by the system variable `□PW`, it will be folded at or before `□PW` and the folded portions indented six spaces. The display of a simple numeric or mixed array may be folded at a width less than `□PW` so that individual numbers are not split across a page boundary.

Example

```
□PW←40

?3 20p100
54 22 5 68 68 94 39 52 84 4 6 53 68
85 53 10 66 42 71 92 77 27 5 74 33 64
66 8 64 89 28 44 77 48 24 28 36 17 49
    1 39 7 42 69 49 94
    76 100 37 25 99 73 76
    90 91 7 91 51 52 32
```

The]display User Command

The user command `]display` illustrates the structure of an array.

Examples

```
]display 'ABC' (1 4p1 2 3 4)
```

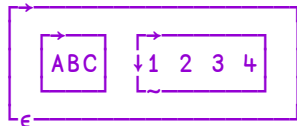

```
]display ' 'PRODUCTS;.,AREAS SALES A see above
```



	West	Central	East
Biscuits	50	5.25	75
Cakes	250	20.15	900
Buns	500	80.98	650
Rolls	1000	90.03	1200

An explanation of the symbols that appear in the borders can be seen by running `]display -?`

The `]boxing` User Command

The user command `]boxing` changes the way in which nested arrays are the displayed in the Session. The following examples show different settings.

Examples

```
]boxing on -style=min
Was OFF -style=min
```

```
'ABC' (1 4p1 2 3 4)
┌───┬───┬───┬───┬───┐
│ ABC │ 1 │ 2 │ 3 │ 4 │
└───┴───┴───┴───┴───┘
```

```
]boxing on -style=mid
Was ON -style=min
```

```
'ABC' (1 4p1 2 3 4)
┌───┬───┬───┬───┬───┐
│ ABC │ 1 │ 2 │ 3 │ 4 │
└───┴───┴───┴───┴───┘
```

```
]boxing on -style=max
Was ON -style=mid
```

```
'ABC' (1 4p1 2 3 4)
┌───┬───┬───┬───┬───┐
│ ABC │ 1 │ 2 │ 3 │ 4 │
└───┴───┴───┴───┴───┘
```

```
]boxing on -style=min
Was ON -style=max
]boxing off
Was ON
```

```
'ABC' (1 4p1 2 3 4)
ABC 1 2 3 4
```

Shy Results

Functions may return shy results.

A shy or suppressed result is a result that is not automatically displayed in the Session, but is suppressed. A shy result of an expression may be displayed by using it as an argument to a function that returns its argument unchanged, by enclosing the expression in parentheses or by assigning it to `□`.

Examples

```
A←10 □ A Result of assignment is shy
(A←10)
10
□DL 2 □ A Result of delay is shy
□←□DL
1.994
foo&88 □ A Result of Spawn (thread number) is shy
→foo&88
6
```

See also:

- [Model Syntax on page 78](#)
- [Shy Result on page 136](#)
- *Language Reference Guide: Execute Expression.*

Prototypes and Fill Items

Every array has an associated *prototype* which is derived from the array's first item.

If the first item is a number, the prototype is 0. Otherwise, if the first item is a character, the prototype is ' '(space). Otherwise, if the first item is a (ref to) an instance of a Class, the prototype is a ref to that Class.

Otherwise (in the nested case, when the first item is other than a simple scalar), the prototype is defined recursively as the prototype of each of the array's first item.

Examples:

Array	Prototype
1 2 3.4	0
2 3 5p'hello'	' '
99 'b' 66	0
(1 2)(3 4 5)	0 0
((1 2)3)(4 5 6)	(0 0)0
'hello' 'world'	' '
☐NEW MyClass	MyClass
(88(☐NEW MyClass)'X')7	0 MyClass ' '

Fill Items

Fill items for an overtake operation, are derived from the argument's prototype. For each 0 or ' ' in the prototype, there is a corresponding 0 or ' ' in the fill item and for each class reference in the prototype, there is a ref to a (newly constructed and distinct) instance of that class that is initialised by the niladic (default) constructor for that class, if defined.

Examples:

```

      4↑1 2
1 2 0 0
      4↑'ab'
ab
      4↑(1 2)(3 4 5)
1 2 3 4 5 0 0 0 0
      2↑☐NEW MyClass
#. [Instance of MyClass] #. [Instance of MyClass]
```

In the last example, two distinct instances are constructed (the first by `NEW` and the second by the `overtake`).

Fill items are used in a number of operations including:

- First (`=` or `↑`) of an empty array
- Fill-elements for `overtake`
- For use with the `Each` operator on an empty array

Cells and Sub-arrays

Certain functions and operators operate on particular cells or sub-arrays of an array, which are identified and described as follows.

K-Cells

A *rank-k* cell or *k-cell* of an array are terms used to describe a sub-array on the last k axes of the array. Negative k is interpreted as $r+k$ where r is the rank of the array, and is used to describe a sub-array on the leading $|k|$ axes of an array.

If X is a 3-dimensional array of shape 2 3 4, the 1-cells are its 6 rows each of 4 elements; and its 2-cells are its 2 matrices each of shape 3 4. Its 3-cells is the array in its entirety. Its 0-cells are its individual elements.

Major Cells

The *major cells* of an array X is a term used to describe the sub-arrays on the leading dimension of the array X with shape $1 \downarrow \rho X$. Using the k -cell terminology, the major cells are its -1 -cells.

The major cells of a vector are its elements (0-cells). The major cells of a matrix are its rows (1-cells), and the major cells of a 3-dimensional array are its matrices along the first dimension (2-cells).

Examples

In the following, the major cells of **A** are 1979, 1990, 1997, 2007, and 2010; those of **B** are 'Thatcher', 'Major', 'Blair', 'Brown', and 'Cameron'; and those of **C** are the four 2-by-3 matrices.

```

      A
1979 1990 1997 2007 2010

```

```

      B
Thatcher
Major
Blair
Brown
Cameron

```

```

      ρB
5 8

```

```

      □←C←4 2 3ρ124
0 1 2
3 4 5

```

```

6 7 8
9 10 11

```

```

12 13 14
15 16 17

```

```

18 19 20
21 22 23

```

Using the k -cell terminology, if r is the rank of the array, its major cells are its $r-1$ -cells.

Note that if the right operand k of the Rank Operator ρ is negative, it is interpreted as $0 \uparrow r+k$. Therefore the value -1 selects the major cells of the array.

Expressions

An expression is a sequence of one or more syntactic tokens which may be symbols or constants or names representing arrays (variables) or functions. An expression which produces an array is called an ARRAY EXPRESSION. An expression which produces a function is called a FUNCTION EXPRESSION. Some expressions do not produce a result.

An expression may be enclosed within parentheses.

Evaluation of an expression proceeds from right to left, unless modified by parentheses. If an entire expression results in an array that is not assigned to a name, then that array value is displayed. (Some system functions and defined functions return an array result only if the result is assigned to a name or if the result is the argument of a function or operator.)

Examples

$$X \leftarrow 2 \times 3 - 1$$

$$2 \times 3 - 1$$

4

$$(2 \times 3) - 1$$

5

Either blanks or parentheses are required to separate constants, the names of variables, and the names of defined functions which are adjacent. Excessive blanks or sets of parentheses are redundant, but permitted. If F is a function, then:

$$F \ 2 \leftrightarrow F(2) \leftrightarrow (F)2 \leftrightarrow (F) (2) \leftrightarrow F (2) \leftrightarrow F ((2))$$

Blanks or parentheses are not needed to separate primitive functions from names or constants, but they are permitted:

$$-2 \leftrightarrow (-)(2) \leftrightarrow (-) 2$$

Blanks or parentheses are not needed to separate operators from primitive functions, names or constants. They are permitted with the single exception that a dyadic operator must have its right argument available when encountered. The following syntactical forms are accepted:

$$(+, \times) \leftrightarrow (+) . \times \leftrightarrow + . (\times)$$

The use of parentheses in the following examples is not accepted:

$$+(\cdot) \times \quad \text{or} \quad (+\cdot) \times$$

Functions

A function is an operation which is performed on zero, one or two array arguments and may produce an array result. Three forms are permitted:

- NILADIC defined for no arguments
- MONADIC defined for a right but not a left argument
- DYADIC defined for a left and a right argument

The number of arguments is referred to as its VALENCE.

The name of a non-niladic function is AMBIVALENT; that is, it potentially represents both a monadic and a dyadic function, though it might not be defined for both. The usage in an expression is determined by syntactical context. If the usage is not defined an error results.

Functions have long SCOPE on the right; that is, the right argument of the function is the result of the entire expression to its right which must be an array. A dyadic function has short scope on the left; that is, the left argument of the function is the array immediately to its left. Left scope may be extended by enclosing an expression in parentheses whence the result must be an array.

For some functions, the explicit result is suppressed if it would otherwise be displayed on completion of evaluation of the expression. This applies on assignment to a variable name. It applies for certain system functions, and may also apply for defined functions.

Examples

```

$$\begin{array}{l} \text{~}30 \quad 10 \times 5 - 2 \times 4 \\ \quad \quad 2 \times 4 \\ 8 \\ \text{~}3 \quad 5 - 8 \\ \text{~}3 \quad 10 \times \text{~}3 \\ \text{~}30 \quad (10 \times 5) - 2 \times 4 \\ 42 \end{array}$$

```

Defined Functions

Functions may be defined with the system function `⎕FX`, or with the function editor. A function consists of a **HEADER** which identifies the syntax of the function, and a **BODY** in which one or more APL statements are specified.

The header syntax identifies the function name, its (optional) result and its (optional) arguments. If a function is ambivalent, it is defined with two arguments but with the left argument within braces (`{}`). If an ambivalent function is called monadically, the left argument has no value inside the function. If the explicit result is to be suppressed for display purposes, the result is shown within braces. A function need not produce an explicit result. Refer to *Chapter 2* for further details.

Example

```

      ▽ R←{A} FOO B
[1]   R←→ 'MONADIC' 'DYADIC' [⎕IO+0≠⎕NC'A']
[2]   ▽

      FOO 1
MONADIC

      'X' FOO 'Y'
DYADIC

```

Functions may also be created by using assignment (`←`).

Function Assignment & Display

The result of a function-expression may be given a name. This is known as FUNCTION ASSIGNMENT (see also [Dfns & Dops on page 133](#)). If the result of a function-expression is not given a name, its value is displayed. This is termed FUNCTION DISPLAY.

Examples

```

      PLUS←+
      PLUS
+
      SUM←+ /
      SUM
+ /

```

Function expressions may include defined functions and operators. These are displayed as a ▽ followed by their name.

Example

```

[1]  ▽ R←MEAN X      A Arithmetic mean
      R←(+ / X) ÷ ρX
      ▽

```

```

      MEAN
▽MEAN

```

```

      AVERAGE←MEAN
      AVERAGE
▽MEAN

```

```

      AVG←MEAN ° ,
      AVG
▽MEAN ° ,

```

Operators

An operator is an operation on one or two operands which produces a function called a DERIVED FUNCTION. An operand may be a function or an array. Operators are not ambivalent. They require either one or two operands as applicable to the particular operator. However, the derived function may be ambivalent. The derived function need not return a result. Operators have higher precedence than functions. Operators have long scope on the left. That is, the left operand is the longest function or array expression on its left. The left operand may be terminated by:

1. the end of the expression
2. the right-most of two consecutive functions
3. a function with an array to its left
4. an array with a function to its left

an array or function to the right of a monadic operator.

A dyadic operator has short scope on the right. That is, the right operand of an operator is the single function or array on its right. Right scope may be extended by enclosing an expression in parentheses.

Examples

```

7 4 5 ρ⌵X←'WILLIAM' 'MARY' 'BELLE'

1 1 1 ρ∘ρ⌵X

1 1 1 (ρ∘ρ)⌵X

[1] ⌵∘←∘⌵VR⌵⌵'PLUS' 'MINUS'
    ▽ R←A PLUS B
    R←A+B
    ▽
    ▽ R←A MINUS B
    R←A-B
    ▽

10 PLUS/1 2 3 4

```

Defined Operators

Operators may be defined with the system function `⎕FX`, or with the function editor. A defined operator consists of a **HEADER** which identifies the syntax of the operator, and a **BODY** in which one or more APL statements are specified.

A defined operator may have one or two operands; and its derived function may have one or two arguments, and may or may not produce a result. The header syntax defines the operator name, its operand(s), the argument(s) to its derived function, and the result (if any) of its derived function. The names of the operator and its operand(s) are separated from the name(s) of the argument(s) to its derived function by parentheses.

Example

```

▽ R←A(F AND G)B
[1]   R←(A F B)(A G B)
▽

```

The above example shows a dyadic operator called **AND** with two operands (**F** and **G**). The operator produces a derived function which takes two arguments (**A** and **B**), and produces a result (**R**).

```

      12 +AND÷ 4
16 3

```

Operands passed to an operator may be either functions or arrays.

```

      12 (3 AND 5) 4
12 3 4 12 5 4

      12 (× AND 5) 4
48 12 5 4

```

Binding Strength

For two entities X and Y that are adjacent in an expression (that is, $X Y$), the binding strength between them and the result of the bind is shown in this table:

		Y							
		A	F	H	MOP	DOP	DOT	IDX	
X	A	6 A	3 AF	3 AF	4 F		7 REF	4 A	
	F	2 A	1 F	4 F	4 F			4 F	
	H		1 F	4 F	4 F			4 H	
	AF	2 A	1 F						
	MOP			4 ERR					
	DOP	5 MOP	5 MOP	5 MOP					
	JOT	5 MOP	5 MOP	5 MOP	4 F				
	DOT	6 ERR	5 MOP	5 MOP		6 ERR			
	REF	7 A	7 F	7 H	7 MOP	7 DOP			
	IDX	3 ERR	3 ERR	3 ERR					

A : *Array, for example, $0\ 1\ 2\ \text{'hello'}\ \alpha\ \omega$

F : *Function (primitive/defined/derived/system), for example, $+\ -\ +.\times$
 $\text{myfn}\ \square\text{CR}\ \{\alpha\ \omega\}$

H : *Hybrid function/operator, that is, $/\ \neq\ \backslash\ \lambda$

AF : Bound left argument, for example, $2+$

MOP : *Monadic operator, for example, $''\ \ddot{\sim}\ \&$

DOP : Dyadic operator, for example, $\times\ \boxtimes\ \ddot{\circ}\ \boxtimes$

JOT : Jot, that is, compose/null operand \circ

DOT : Dot, that is, reference/product $.$

IDX : square-bracketed expression, for example, $[\alpha+\iota\omega]$

ERR : Error

* indicates a "first-class" entity, which can be parenthesised or named

In this table:

- the higher the number, the stronger the binding
- an empty field indicates no binding for this combination; an error.

For example, in the expression `a b.c[d]`, where `a`, `b`, `c` and `d` are arrays, the binding proceeds:

	<code>a b . c [d]</code>	
	<code>6 7 6 4</code>	<code>A binding strengths between entities</code>
→	<code>a (b.) c [d]</code>	
	<code>0 7 4</code>	
→	<code>a (b.c) [d]</code>	
	<code>6 4</code>	
→	<code>(a(b.c))[d]</code>	

Function Trains

Introduction

A *Train* is a derived function constructed from a sequence of 2 or 3 functions, or from an array followed by two functions, which bind together to form a function.

Forks and Atops

The following trains are currently supported where **f**, **g** and **h** are functions and **A** is an array:

```
f g h
A g h
g h
```

The 3-item trains (**f g h**) and (**A g h**) are termed *forks* while the 2-item train (**g h**) is termed an *atop*. To distinguish the two styles of *fork*, we can use the terms *fgh-fork* or *Agh-fork*.

Trains as Functions

A train is syntactically equivalent to a function and so, in common with any other function, may be:

- named using assignment
- applied to or between arguments
- consumed by operators as an operand
- and so forth.

In particular, trains may be applied to a single array (monadic use) or between 2 arrays (dyadic use), providing six new constructs.

$\alpha(f\ g\ h)\omega$	\leftrightarrow	$(\alpha\ f\ \omega)\ g\ (\alpha\ h\ \omega)$	A dyadic (fgh) fork
$\alpha(A\ g\ h)\omega$	\leftrightarrow	A g ($\alpha\ h\ \omega$)	A dyadic (Agh) fork
$\alpha(\ g\ h)\omega$	\leftrightarrow	g ($\alpha\ h\ \omega$)	A dyadic atop
$(f\ g\ h)\omega$	\leftrightarrow	(f ω) g (h ω)	A monadic (fgh) fork
$(A\ g\ h)\omega$	\leftrightarrow	A g (h ω)	A monadic (Agh) fork
$(\ g\ h)\omega$	\leftrightarrow	g (h ω)	A monadic atop

Identifying a Train

For a sequence to be interpreted as a train it must be separated from the argument to which it is applied. This can be done using parentheses or by naming the derived function.

Example - fork: negation of catenated with reciprocal

```
(-, ÷)5
~5 0.2
```

Example - named fork

```
negrec←-, ÷
negrec 5
~5 0.2
```

Whereas, without these means to identify the sequence as a train, the expression:

```
-, ÷ 5
~0.2
```

means the negation of the ravel of the reciprocal of 5.

Idiom Recognition

Function trains lend themselves to idiom recognition, a technique used to optimise the performance of certain expressions.

Example

An expression to find the first position in a random integer vector X of a number greater than 999000 is:

```
X←?1e6p1e6
(X≥999000)ι1
1704
```

A function train is not only more concise, it is faster too.

```
X (ι•1 ≥) 999000
1704
```

Trains of Trains

As a train resolves to a function, a sequences of more than 3 functions represents a train of trains. Function sequences longer than 3 are bound in threes, starting from the right:

... fu fv fw fx fy fz → ... fu (fv fw (fx fy fz))

This means that, in the absence of parentheses, a sequence of an odd number of functions resolves to a 3-train (fork) and an even-numbered sequence resolves to a 2-train (atop):

e f g h i j k → e f(g h(i j k)) A fork(fork(fork))
 f g h i j k → f(g h(i j k)) A atop(fork(fork))

Examples

6(+,-,×,÷)2 A fork:(6+2),((6-2),((6×2),(6÷2)))
 8 4 12 3

6(φ+, - , × , ÷)2 A atop: φ (6+2), ...
 3 12 4 8

]boxing on
 Was OFF

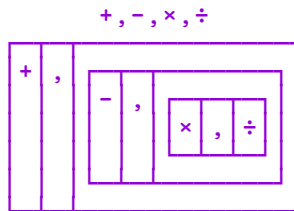

A boxed display of fork

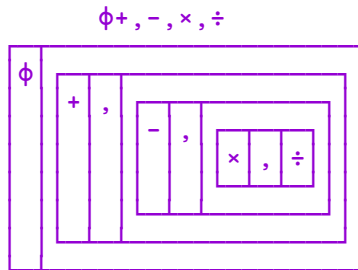

A boxed display of atop

]boxing -trains=tree
 Was -trains=box

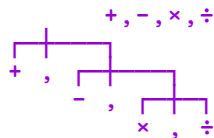

A boxed (tree) display of fork

Binding Strengths

The binding strength between the items of a train is less than that of operand-operator binding. In other words, operators bind first with their function (or array) operands to form derived functions, which may then participate as items in a train.

Example:

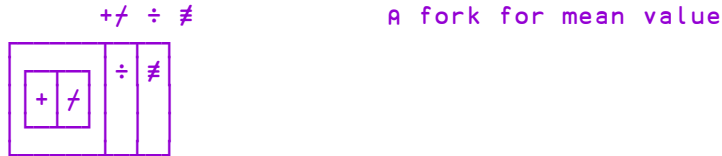

This means that any of the four hybrid tokens / ≠ \ ≠ will not be interpreted as a function if there's a function to its left in the train. In order to fix one of these tokens as a replicate or expand function, it must be isolated from the function to its left:

(ι/ι)3 A → ι/ atop ι3 → RANK ERROR
RANK ERROR

(ι{α/ω}ι)3 A → (ι3){α/ω}(ι3) → (ι3)/(ι3)
1 2 2 3 3 3

(ι(/οι)ι)3 A → (ι3)/ι(ι3)
1 2 2 3 3 3

(2/ι)3 A Agh-fork is OK
1 1 2 2 3 3

Parallel Execution

If your computer has more than one CPU or is a multi-core processor, then the scalar dyadic functions \div , \geq , $=$, \leq , \otimes , $|$, $!$, \circ , \vee and \wedge will, when applied to arrays with a sufficiently large number of elements, execute in parallel in separate system threads.

For example, if you have a computer with 4 cores (either real or virtual) and execute an expression such as $(A \div B)$ where A and/or B contain more than 32,768 elements, then Dyalog will start 4 separate threads, each performing the division on $\frac{1}{4}$ of the elements of the array(s) and simultaneously creating the corresponding $\frac{1}{4}$ of the result array. The threads are only started once, and are reused for subsequent multi-threaded operations.

The maximum number of threads to use can be controlled using `1111I`, and the parallel execution threshold is changed using `1112I`. These "tuning" I-beams should be considered experimental, and may be changed or replaced in a future release. (See *Language Reference Guide: Number of Threads and Parallel Execution Threshold*).

Note that these scalar dyadic functions are not multi-threaded when applied to arrays of Boolean or integer values, they are also not multi-threaded for $+$, $-$ or \times when applied to arrays of 64 bits floating (type 645). Tests show that the overhead of preparing such arrays for multi-threaded operations outweighs the performance benefits.

Complex Numbers

A complex number is a number consisting of a real and an imaginary part which is usually written in the form $a+bi$, where a and b are real numbers, and i is the standard imaginary unit with the property $i^2 = -1$.

Dyalog APL adopts the J notation introduced in IBM APL2 to represent the value of a complex number which is written as **aJb** or **ajb** (without spaces). The former representation (with a capital **J**) is always used to display a value.

Notation

`2+-1*.5`
2J1

`.3j.5`
0.3J0.5

`1.2E5J-4E-4`
120000J^{-0.0004}

Arithmetic

The arithmetic primitive functions handle complex numbers in the appropriate way.

`2j3+.3j.5` **A** $(a+bi)+(c+di) = (a+c)+(b+d)i$
2.3J3.5

`2j3-.3j5` **A** $(a+bi)-(c+di) = (a-c)+(b-d)i$
1.7J⁻²

`2j3×.3j.5` **A** $(a+bi)(c+di) = ac+bc i+adi+bd i^2$
A $= (ac-bd)+(bc+ad)i$
^{-0.9}J1.9

The absolute value, or magnitude of a complex number is naturally obtained using the Magnitude function

```
5      |3j4
```

Monadic `+` of a complex number $(a+bi)$ returns its conjugate $(a-bi)$...

```
3j4   +3j4
3j^-4
```

... which when multiplied by the complex number itself, produces the square of its magnitude.

```
25      3j4*3j^-4
```

Furthermore, adding a complex number and its conjugate produces a real number:

```
6      3j4+3j^-4
```

The famous Euler's Identity may be expressed as follows:

```
0      1+*o0j1 A Euler Identity
```

Different Result for Power

From Version 13.0 onwards, the implementation of `X*Y` (Power) gives a different answer for negative real `X` than in all previous Versions of Dyalog APL. This change is however in accordance with the ISO/IEC 13751 Standard for Extended APL.

In Version 13.0 onwards, the result is the principal value; whereas in previous Versions the result is a negative or positive real number or `DOMAIN ERROR`. The following examples illustrate this point:

```
-2 4      ^-8 * 1 2 ÷ 3      A Version 12.1
```

```
1j1.732050808 ^-2j3.464101615      A Version 13.0
```

```
* (1 2 ÷ 3) × * ^-8      A Version 13.0
1j1.732050808 ^-2j3.464101615
```

Circular functions

The basic set of circular functions $X \circ Y$ cater for complex values in Y , while the following extended functions provide specific features for complex arguments. Note that a and b are the real and imaginary parts of Y respectively and θ is the phase of Y .

$(-X) \circ Y$	X	$X \circ Y$
$-8 \circ Y$	8	$(-1+Y*2)*0.5$
Y	9	a
+Y	10	Y
$Y \times 0J1$	11	b
$*Y \times 0J1$	12	θ

Note that $9 \circ Y$ and $11 \circ Y$ return the real and imaginary parts of Y respectively:

$$9 \circ 3.5J^{-1.2} = 3.5$$

$$11 \circ 3.5J^{-1.2} = -1.2$$

Comparison

In comparing two complex numbers X and Y , $X=Y$ is 1 if the magnitude of $X-Y$ does not exceed ϵ_{CT} times the larger of the magnitudes of X and Y ; geometrically, $X=Y$ if the number smaller in magnitude lies on or within a circle centred on the one with larger magnitude, having radius ϵ_{CT} times the larger magnitude.

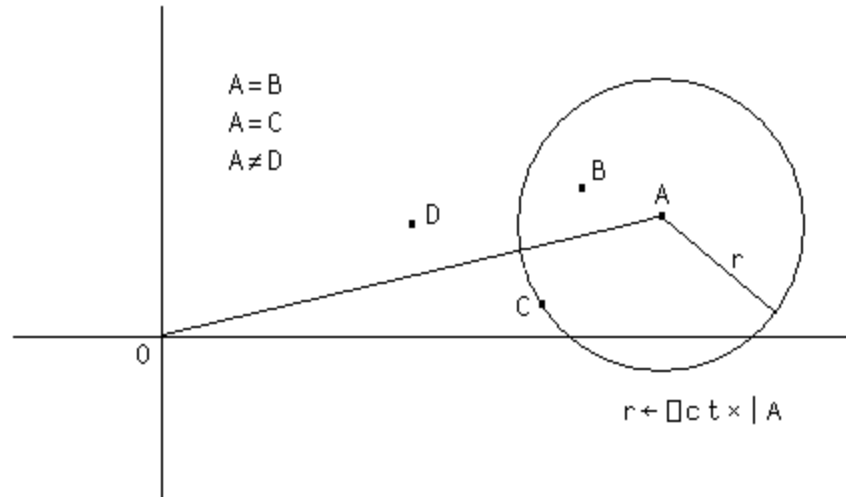

As with real values, complex values sufficiently close to Boolean or integral values are accepted by functions which require Boolean or integral values. For example:

```

2j1e-14 ρ 12
12 12 0 ∼ 1j1e-15
0

```

Note that Dyalog APL always stores complex numbers as a pair of 64-bit binary floating-point numbers, regardless of the setting of ϵ_{FR} . Comparisons between complex numbers and decimal floating-point numbers will require conversion of the decimal number to binary to allow the comparison. When $\epsilon_{FR}=1287$, comparisons are always subject to ϵ_{DCT} , not ϵ_{CT} - regardless of the data type used to represent a number.

This only really comes into play when determining whether the imaginary part of a complex number is so small that it can be considered to be on the real line. However, Dyalog recommends that you do not mix the use of complex and decimal numbers in the same component of an application.

128 Bit Decimal Floating-Point Support

Introduction

The original IEEE-754 64-bit binary floating point (FP) data type (also known as type number 645), that is used internally by Dyalog APL to represent floating-point values, does not have sufficient precision for certain financial computations – typically involving large currency amounts. The binary representation also causes errors to accumulate even when all values involved in a calculation are "exact" (rounded) decimal numbers, since many decimal numbers cannot be accurately represented regardless of the precision used to hold them. To reduce this problem, Dyalog APL includes support for the 128-bit decimal data type described by IEEE-754-2008 as an alternative representation for floating-point values.

System Variable: `⎕FR`

Computations using 128-bit decimal numbers require twice as much space for storage, and run more than an order of magnitude more slowly on platforms which do not provide hardware support for the type. At this time, hardware support is only available from IBM (POWER 6 chips onwards, and recent System z mainframes). Even with hardware support, a slowdown of a factor of 4 can be expected. For this reason, Dyalog allows users to decide whether they need the higher-precision decimal representation, or prefer to stay with the faster and smaller binary representation.

The system variable `⎕FR` (for Floating-point Representation) can be set to the value 645 (the installed default) to indicate 64-bit binary FP, or 1287 for 128-bit decimal FP. The default value of `⎕FR` is configurable.

Simply put, the value of `⎕FR` decides the type of the result of any floating-point calculation that APL performs. In other words, when entered into the session:

```
⎕FR = ⎕DR 1.234  A Type of a floating-point constant
⎕FR = ⎕DR 3÷4   A Type of any floating-point result
```

`FR` has workspace scope, and may be localised. If so, like most other system variables, it inherits its initial value from the global environment.

However: Although `FR` *can* vary, the system is not designed to allow "seamless" modification during the running of an application and the dynamic alteration of `FR` is not recommended. Strange effects may occur. For example, the type of a constant contained in a line of code (in a function or class), will depend on the value of `FR` *when the function is fixed*. Similarly, a constant typed into a line in the Session is evaluated using the value of `FR` that pertained **before** the line is executed. Thus, it would be possible for the first line of code above to return 0, if it is in the body of a function. If the function was edited and while suspended and execution is resumed, the result would become 1. Also note:

```

FR←1287
x←1÷3

FR←645
x=1÷3
1

```

The decimal number has 17 more 3s. Using the tolerance which applies to binary floats (type 645), the numbers are equal. However, the "reverse" experiment yields 0, as tolerance is much narrower in the 128-bit universe:

```

FR←645
x←1÷3

FR←1287
x=1÷3
0

```

Since `FR` can vary, it will be possible for a single workspace to contain floating-point values of both types (existing variables are not converted when `FR` is changed). For example, an array that has just been brought into the workspace from external storage may have a different type from `FR` in the current namespace. Conversion (if necessary) will only take place when a *new* floating-point array is generated as the result of "a calculation". The result of a computation returning a floating-point result will *not* depend on the type of the arrays involved in the expression: `FR` at the time when a computation is performed decides the result type, alone.

Structural functions generally do NOT change the type, for example:

```

□FR←1287
x←1.1 2.2 3.3

□FR←645
□dr x
1287
□dr 2↑x
1287

```

128-bit decimal numbers not only have greater precision (roughly 34 decimal digits); they also have significantly larger range- from $-1E6145$ to $1E6145$. Loss of precision is accepted on conversion from 645 to 1287, but the magnitude of a number may make the conversion impossible, in which case a **DOMAIN ERROR** is issued:

```

□FR←1287
x←1E1000

□FR←645
x+0
DOMAIN ERROR

```

WARNING: The use of **COMPLEX** numbers when **□FR** is 1287 is not recommended, because:

- any 128-bit decimal array into which a complex number is inserted or appended will be forced in its entirety into complex representation, potentially losing precision
- all comparisons are done using **□DCT** when **□FR** is 1287, and this is equivalent to 0 for complex numbers.

Conversion between Decimal and Binary

Conversion of data from Binary to Decimal is logically equivalent to formatting, and the reverse conversion is equivalent to evaluating input. These operations are performed according to the same rules that are used when formatting (and evaluating) numbers with **□PP** set to 17 (guaranteeing that the decimal value can be converted back to the same binary bit pattern). Because the precision of decimal floating-point numbers is much higher, there will always be a large number of potential decimal values which map to the same binary number: As with formatting, the rule is that the **SHORTEST** decimal number which maps to a particular binary value will be used as its decimal representation.

Data in component files will be stored without conversion, and only converted when a computation happens. It should be stored in decimal form if it will repeatedly be used by application code in which `⎕FR` has the value 1287. Even in applications which use decimal floating point everywhere, reading old component files containing arrays of type 645, or receiving data via `⎕NA`, the .NET interface or other external sources, will allow binary floating-point values to enter the system and require conversion.

⎕DCT - Decimal Comparison Tolerance

When `⎕FR` has the value 1287, the system variable `⎕DCT` will be used to specify comparison tolerance. The default value of `⎕DCT` is $1E^{-28}$, and the maximum value is $2.3283064365386962890625E^{-10}$ (the value is chosen to avoid fuzzy comparison of 32-bit integers).

Passing floating-point values using ⎕NA

`⎕NA` supports the data type "D" to represent the Densely Packed Decimal (DPD) form of 128-bit decimal numbers, as specified by the IEEE-754 2008 standard. Dyalog has decided to use DPD, which is the format used by IBM for hardware support, on ALL platforms, although "Binary Integer Decimal" (BID) is the format that Intel libraries use to implement software libraries to do decimal arithmetic. Experiments have shown that the performance of 128-bit DPD and BID libraries are very similar on Intel platforms. In order to avoid the added complication of having two internal representations, Dyalog has elected to go with the hardware format, which is expected to be adopted by future hardware implementations.

The support libraries for writing APs and DLLs include new functions to extract the contents of a value of type D as a string or double-precision binary "float" – and convert data to D format.

Decimal Floats and Microsoft.NET

The Microsoft.NET framework contains a type named `System.Decimal`, which implements decimal floating-point numbers. However, it uses a different internal format from that defined by IEEE-754 2008.

Dyalog APL includes a Microsoft.NET class (called `Dyalog.Dec128`), which will perform arithmetic on data represented using the "Binary Integer Decimal" format. All computations performed by the `Dyalog.Dec128` class will produce exactly the same results as if the computation was performed in APL. A "DCT" property allows setting the comparison tolerance to be used in comparisons, `Ceiling/Floor`, etc.).

The Dyalog class is modelled closely after the existing System.Decimal type, providing the same methods (Add, Ceiling, Compare, CompareTo, Divide, Equals, Finalize, Floor, FromOACurrency, GetBits, GetHashCode, GetType, GetTypeCode, MemberwiseClone, Multiply, Negate, Parse, Remainder, Round, Subtract, To*, Truncate, TryParse) and operators (Addition, Decrement, Division, Equality, Explicit, GreaterThan, GreaterThanOrEqual, Implicit, Increment, Inequality, LessThan, LessThanOrEqual, Modulus, Multiply, Subtraction, UnaryNegation, UnaryPlus).

The "bridge" between Dyalog and .NET is able to cast floating-point numbers to or from System.Double, System.Decimal and Dyalog.Dec128 (and perform all other reasonable casts to integer types etc.). Casting a Dyalog.Dec128 to or from strings will perform a "lossless" conversion.

Incoming .NET data types VT_DECIMAL (96-bit integer) and VT_CY (currency value represented by a 64-bit two's complement integer, scaled by 10,000) are converted to 126-bit decimal numbers (DECFS). This conversion is performed independently of the value of `DFR`.

If you want to perform arithmetic on values imported in this way, then you should set `DFR` to 1287, at least for the duration of the calculations.

Note that the .NET interface converts System.Decimal to DECFS but does not convert System.Int64 to DECFS.

Namespaces

Namespace is a (class 9) object in Dyalog APL. Namespaces are analogous to nested workspaces.

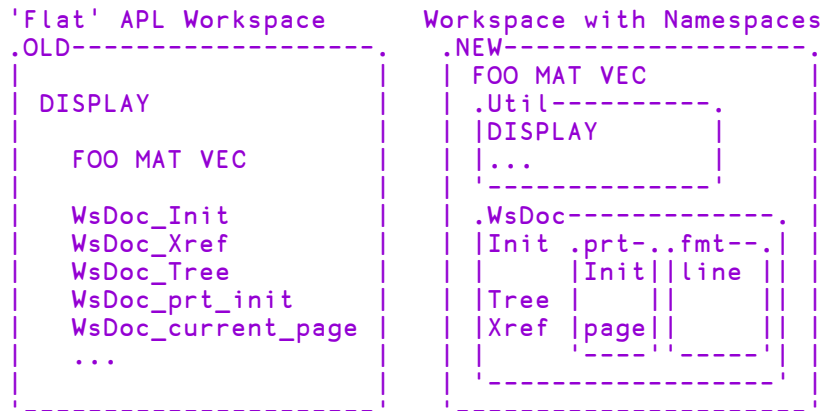

They provide the same sort of facility for workspaces as directories do for filesystems. The analogy, based on DOS, might prove helpful:

Operation	Windows	Namespace
Create	mkdir)NS or □NS
Change	cd)CS or □CS
Relative name	dir1\dir\file	NS1.NS2.OBJ
Absolute name	\file\file	#.NS.OBJ
Name separator	\	.
Top (root) object	\	#
Parent object	..	##

Namespaces bring a number of major benefits:

They provide lexical (as opposed to dynamic) local names. This means that a defined function can use local variables and functions which persist when it exits and which are available next time it is called.

Just as with the provision of directories in a filing system, namespaces allow us to organise the workspace in a tidy fashion. This helps to promote an object oriented programming style.

APL's traditional name-clash problem is ameliorated in several ways:

- Workspaces can be arranged so that there are many fewer names at each namespace level. This means that when copying objects from saved workspaces there is a much reduced chance of a clash with existing names.
- Utility functions in a saved workspace may be coded as a single namespace and therefore on being copied into the active workspace consume only a single name. This avoids the complexity and expense of a solution which is sometimes used in 'flat' workspaces, where such utilities dynamically fix local functions on each call.
- In flat APL, workspace administration functions such as **WSDOC** must share names with their subject namespace. This leads to techniques for trying to avoid name clashes such as using obscure name prefixes like '**△△L 1**'. This problem is now virtually eliminated because such a utility can operate exclusively in its own namespace.

The programming of GUI objects is considerably simplified.

- An object's callback functions may be localised in the namespace of the object itself.
- Static variables used by callback functions to maintain information between calls may be localised within the object.

This means that the object need use only a single name in its namespace.

Namespace Syntax

Names within namespaces may be referenced *explicitly* or *implicitly*. An *explicit* reference requires that you identify the object by its full or relative pathname using a '.' syntax; for example:

```
X.NUMB ← 88
```

sets the variable **NUMB** in namespace **X** to 88.

```
88 UTIL.FOO 99
```

calls dyadic function **FOO** in namespace **UTIL** with left and right arguments of 88 and 99 respectively. The interpreter can distinguish between this use of '.' and its use as the inner product operator, because the leftmost name: **UTIL** is a (class 9) namespace, rather than a (class 3) function.

The general namespace reference syntax is:

```
SPACE . SPACE . (...) EXPR
```

Where **SPACE** is an *expression* which resolves to a namespace reference, and **EXPR** is any APL expression to be resolved in the resulting namespace.

There are two special space names:

is the top level or 'Root' namespace.

is the parent or space containing the current namespace.

□SE is a system namespace which is preserved across workspace load and clear.

Examples

```
WSDOC.PAGE.NO +← 1      A Increment WSDOC page count
#.□NL 2                A Variables in root space
UTIL.□FX 'Z←DUP A' 'Z←A A'  A Fix remote function
##.□ED'FOO'           A Edit function in parent space
□SE.RECORD ← PERS.RECORD  A Copy from PERS to □SE
UTIL.(□EX □NL 2)      A Expunge variables in UTIL

(⇒□SE #).(⊢⇒↓□NL 9).(□NL 2)  A Vars in first □SE
                             A namespace.
UTIL.⊢STRING          A Execute STRING in UTIL space
```

You may also reference a function or operator in a namespace *implicitly* using the mechanism provided by `EXPORT` (See *Language Reference Guide: Export*) and `PATH`. If you reference a name that is undefined in the current space, the system searches for it in the list of exported names defined for the namespaces specified by `PATH`. See *Language Reference Guide: Search Path* for further details.

Notice that the expression to the right of a dot may be arbitrarily complex and will be executed within the namespace or ref to the left of the dot.

```

      X.(C←A×B)
      X.C
10 12 14
16 18 20
      NS1.C
10 12 14
16 18 20

```

Summary

Apart from its use as a decimal separator (`3.14`), `'.'` is interpreted by looking at the type or *class* of the expression to its left:

Template	Interpretation	Example
<code>o.</code>	Outer product	<code>2 3 o.× 4 5</code>
<code>function.</code>	Inner product	<code>2 3 +.× 4 5</code>
<code>ref.</code>	Namespace reference	<code>2 3 x.foo 4 5</code>
<code>array.</code>	Reference array expansion	<code>(x y).nc='foo'</code>

Namespace Reference Evaluation

When the interpreter encounters a namespace reference, it:

1. Switches to the namespace.
2. Evaluates the name.
3. Switches back to the original namespace.

If for example, in the following, the current namespace is `#.W`, the interpreter evaluates the line:

```
A ← X.Y.DUP MAT
```

in the following way:

1. Evaluate array `MAT` in current namespace `W` to produce argument for function.
2. Switch to namespace `X.Y` within `W`.
3. Evaluate function `DUP` in namespace `W.X.Y` with argument.
4. Switch back to namespace `W`.
5. Assign variable `A` in namespace `W`.

Namespaces and Localisation

The rules for name resolution have been generalised for namespaces.

In flat APL, the interpreter searches the state indicator to resolve names referenced by a defined function or operator. If the name does not appear in the state indicator, then the workspace-global name is assumed.

With namespaces, a defined function or operator is evaluated in its 'home' namespace. When a name is referenced, the interpreter searches only those lines of the state indicator which belong to the home namespace. If the name does not appear in any of these lines, the home namespace-global value is assumed.

For example, if `#.FN1` calls `XX.FN2` calls `#.FN3` calls `XX.FN4`, then:

FN1:

- is evaluated in `#`
- can see its own dynamic local names
- can see global names in `#`

FN2:

- is evaluated in `XX`
- can see its own dynamic local names
- can see global names in `XX`

FN3:

- is evaluated in `#`
- can see its own dynamic local names
- can see dynamic local names in `FN1`
- can see global names in `#`

FN4:

- is evaluated in `XX`
- can see its own dynamic local names
- can see dynamic local names in `FN2`
- can see global names in `XX`

The following picture illustrates how APL looks down the stack to find names:

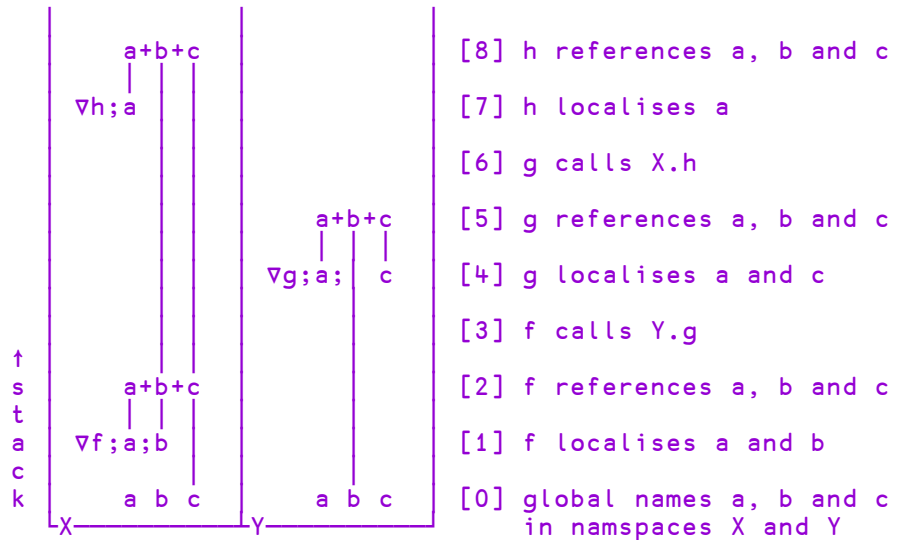

The above diagram represents the SI stack, growing upwards from two namespaces *X* and *Y*, which each have three global names *a*, *b* and *c*.

1. Function *f* in *X* localises names *a* and *b*.
2. Function *f* references names *a*, *b* and *c*.

```

      ▽ f;a;b
[1]  a+b+c
[2]  Y.g

```

The interpreter looks down the stack and finds local names *a* and *b* in *f*'s header and *c* in namespace *X*.

3. Function *f* calls function *g* in namespace *Y*.
4. Function *g* in *Y* localises names *a* and *c*.
5. Function *g* references names *a*, *b* and *c*.

```

      ▽ g;a;c
[1]  a+b+c
[2]  X.h

```

The interpreter looks down the stack and finds local names *a* and *c* in *g*'s header and *b* in namespaces *Y*.

6. Function `g` calls function `h` in namespace `X`.
7. Function `h` in `X` localises name `a`.
8. Function `h` references names `a`, `b` and `c`.

```
      ▽ h;a  
[1]   a+b+c
```

The interpreter looks down the stack and finds local name `a` in `h`'s header; `b` in `f`'s header; and `c` in namespace `X`.

Namespace References

A *namespace reference*, or *ref* for short, is a unique data type that is distinct from and in addition to *number* and *character*.

Any expression may result in a ref, but the simplest one is the namespace itself:

```

)NS NS1           A Make a namespace called NS1
NS1.A←1          A and populate it with variables A
NS1.B←2 3p16     A and B

# NS1            A expression results in a ref

```

You may assign a ref, for example:

```

X←NS1
X
# NS1

```

In this case, the display of `X` informs you that `X` refers to the named namespace `# NS1`.

You may also supply a ref as an argument to a defined function or a dfn:

```

▽ FOO ARG
[1] ARG
▽
# NS1 FOO NS1

```

The name class of a *ref* is 9.

```

□NC 'X'
9

```

You may use a ref to a namespace anywhere that you would use the namespace itself. For example:

```

X.A
1
X.B
1 2 3
4 5 6

```

Notice that refs are references to namespaces, so that if you make a copy, it is the reference that is copied, not the namespace itself. This is sometimes referred to as a shallow as opposed to a deep copy. It means that if you change a ref, you actually change the namespace that it refers to.

```

      X.A←+1
      X.A
2
      NS1.A
2

```

Similarly, a ref passed to a defined function is call-by-reference, so that modifications to the content or properties of the argument namespace using the passed reference persist after the function exits. For example:

```

      ▽ FOO nsref
[1]   nsref.B←+nsref.A
      ▽

      FOO NS1
      NS1.B
3 4 5
6 7 8
      FOO X
      NS1.B
5 6 7
8 9 10

```

Notice that the expression to the right of a dot may be arbitrarily complex and will be executed within the namespace or ref to the left of the dot.

```

      X.(C←A×B)
      X.C
10 12 14
16 18 20
      NS1.C
10 12 14
16 18 20

```

Unnamed Namespaces

The monadic form of `□NS` makes a new (and unique) unnamed namespace and returns a ref to it.

One use of unnamed namespaces is to represent hierarchical data structures; for example, a simple employee database:

The first record is represented by `JOHN` which is a ref to an *unnamed* namespace:

```
JOHN←□NS ''
JOHN
#. [Namespace]

JOHN.FirstName←'John'
JOHN.FirstName
John

JOHN.LastName←'Smith'
JOHN.Age←50
```

Data variables for the second record, `PAUL`, can be established using strand, or vector, assignment:

```
PAUL←□NS ''
PAUL.(FirstName LastName Age←'Paul' 'Brown' 44)
```

The function `SHOW` can be used to display the data in each record (the function is split into 2 lines only to fit on the printed page). Notice that its argument is a ref.

```
▽ R←SHOW PERSON
[1] R←PERSON.FirstName,' ',PERSON.LastName
[2] R, ←' is ',⊘PERSON.Age
▽

SHOW JOHN
John Smith is 50

SHOW PAUL
Paul Brown is 44
```

An alternative version of the function illustrates the use of the `:With` `:EndWith` control structure to execute an expression, or block of expressions, within a namespace:

```
    ▽ R←SHOW1 PERSON
[1]   :With PERSON
[2]     R←FirstName,' ',LastName,' is ',(⌘Age)
[3]   :EndWith
    ▽
    SHOW1 JOHN
John Smith is 50
```

In this case, as only a single expression is involved, it can be expressed more simply using parentheses.

```
    ▽ R←SHOW2 PERSON
[1]   R←PERSON.(FirstName,' ',LastName,' is ',(⌘Age))
    ▽
    SHOW2 PAUL
Paul Brown is 44
```

Dfns also accept refs as arguments:

```
    SHOW3←{
      ω.(FirstName,' ',LastName,' is ',⌘Age)
    }
    SHOW3 JOHN
John Smith is 50
```

Arrays of Namespace References

You may construct arrays of refs using strand notation, catenate (,) and reshape (ρ).

```
EMP←JOHN PAUL
ρEMP
```

2

```
EMP
#. [Namespace] #. [Namespace]
```

Like any other array, an array of refs has name class 2:

```
□NC 'EMP'
```

2

Expressions such as indexing and pick return refs that may in turn be used as follows:

```
EMP[1].FirstName
John
(2>EMP).Age
44
```

The each (``) operator may be used to apply a function to an array of refs:

```
SHOW``EMP
John Smith is 50 Paul Brown is 44
```

An *array* of namespace references (refs) to the left of a '.' is expanded according to the following rule, where x and y are refs, and exp is an arbitrary expression:

$$(x\ y).exp \rightarrow (x.exp)(y.exp)$$

If exp evaluates to a function, the items of its argument array(s) are *distributed* to each referenced function. In the dyadic case, there is a 3-way distribution among: left argument, referenced functions and right argument.

Monadic function f :

$$(x\ y).f\ d\ e \rightarrow (x.f\ d)(y.f\ e)$$

Dyadic function g :

$$a\ b\ (x\ y).g\ d\ e \rightarrow (a\ x.g\ d)(b\ y.g\ e)$$

An array of refs to the left of an assignment arrow is expanded thus:

$$(x\ y).a\leftarrow c\ d \rightarrow (x.a\leftarrow c)(y.a\leftarrow d)$$

Note that the array of refs can be of any rank. In the limiting case of a simple scalar array, the *array* construct: `refs.exp` is identical to the *scalar* construct: `ref.exp`.

Note that the expression to the right of the `'.'` *pervades* a nested array of refs to its left:

$$((u\ v)(x\ y)).exp \rightarrow ((u.exp)(v.exp))((x.exp)(y.exp))$$

Note also that with *successive* expansions `(u v).(x y z). ...`, the final number of "leaf" terms is the *product* of the number of refs at each level.

Examples:

```

JOHN.Children←[]NS'''' ''
ρJOHN.Children
2
JOHN.Children[1].FirstName←'Andy'
JOHN.Children[1].Age←23

JOHN.Children[2].FirstName←'Katherine'
JOHN.Children[2].Age←19

PAUL.Children←[]NS'''' ''
PAUL.Children[1].(FirstName Age←'Tom' 25)
PAUL.Children[2].(FirstName Age←'Jamie' 22)

ρEMP
2
(>EMP).Children.(FirstName Age)
Andy 23  Katherine 19

]display (2>EMP).Children.(FirstName Age)

```

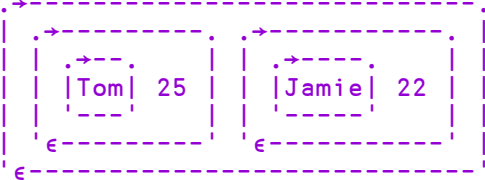

```

EMP.Children ρ Is an array of refs
#[Namespace] #[Namespace] #[Namespace] ...

EMP.Children.(FirstName Age)
Andy 23  Katherine 19  Tom 25  Jamie 22

```

Distributed Assignment

Assignment pervades nested strands of names to the left of the arrow. The conformability rules are the same as for scalar (pervasive) dyadic primitive functions such as '+'. The mechanism can be viewed as a way of naming the parts of a *structure*.

Examples:

```
EMP.(FirstName Age)
JOHN 43 PAUL 44
```

```
EMP.(FirstName Age)←('Jonathan' 21)('Pauline' 22)
```

```
EMP.(FirstName Age)
Johnathan 21 Pauline 22
```

A Distributed assignment is pervasive

```
JOHN.Children.(FirstName Age)
Andy 23 Katherine 19
```

```
JOHN.Children.(FirstName Age)←('Andrew' 21)('Kate'
9)
```

```
JOHN.Children.(FirstName Age)
Andrew 21 Kate 9
```

More Examples:

```

((a b)(c d))←(1 2)(3 4)    A a←1 ◊ b←2 ◊ c←3 ◊ d←4
((io ml)vec)←0 av        A io←0 ◊ ml←0 ◊ vec←av
(i (j k))←+1 2           A i←+1 ◊ j←+2 ◊ k←+2

```

A Naming of parts:

```
((first last) sex (street city state))←n>pvec
```

A Distributed assignment in :For loop:

```
:For (i j)(k l) :In array
```

A Ref array expansion:

```
(x y).(first last)←('John' 'Doe')('Joe' 'Blow')
(f1 f2).(b1 b2).Caption←c'OK' 'Cancel'
```

A Structure rearrangement:

```

rotate1←{                A Simple binary tree rotation.
  (a b c)d e←ω
  a b(c d e)
}
rotate3←{                A Compound binary tree rotation.
  (a b(c d e))f g←ω
  (a b c)d(e f g)
}

```



```

(x y).NL 2 3           A x:vars, y:fns
varx  funy

(x y).NL<2 3         A x&y: vars&fns
funx  funy
varx  vary

(x y).(NL'')<2 3    A x&y: separate vars&fns
varx  funx  vary  funy

'v'(x y).NL 2 3     A x:v-vars, y:v-fns
varx

'vf'(x y).NL 2 3    A x:v-vars, y:f-fns
varx  funy

'vf'(x y).NL<2 3    A x:v-vars&fns,
                    A y:f-vars&fns
varx  funy

x.NL 2 3            A depth 0 ref
funx
varx

(x y).NL<2 3        A depth 1 refs
funx  funy
varx  vary

((u v)(x y)).NL<<2 3  A depth 2 refs
funu  funv  funx  funy
varu  varv  varx  vary

(1 2)3 4(w(x y)z).+1 2(3 4) A arg distribution.
2 3  5 5  7 8

```

Namespaces and Operators

A function passed as operand to a primitive or defined operator, carries its namespace context with it. This means that if subsequently, the function operand is applied to an argument, it executes in its home namespace, irrespective of the namespace from which the operator was invoked or defined.

Examples

```

VAR←99
#.#.VAR
)NS X
#.X
X.VAR←77
X.□FX'Z←FN R' 'Z←R,VAR'
#.#.Y
)NS Y
#.Y
Y.VAR←88
Y.□FX'Z←(F OP)R' 'Z←F R'
X.FN"l3
1 77 2 77 3 77
X.FN 'VAR:'
VAR: 77
X.FN Y.OP 'VAR:'
VAR: 77
± Y.OP'VAR'
99

```

Threads

Overview

Dyalog APL supports multithreading - the ability to run more than one APL expression at the same time.

This unique capability allows you to perform background processing, such as printing, database retrieval, database update, calculations, and so forth while at the same time perform other interactive tasks.

Multithreading may be used to improve throughput and system responsiveness.

A *thread* is a strand of execution in the APL workspace.

A thread is created by calling a function *asynchronously*, using the primitive operator 'spawn': & or by the asynchronous invocation of a callback function.

With a traditional APL *synchronous* function call, execution of the calling environment is paused, *pendent* on the return of the called function. With an *asynchronous* call, both calling environment and called function proceed to execute concurrently.

An asynchronous function call is said to start a new *thread* of execution. Each thread has a unique *thread number*, with which, for example, its presence can be monitored or its execution terminated.

Any thread can spawn any number of sub-threads, subject only to workspace availability. This implies a hierarchy in which a thread is said to be a *child thread* of its *parent thread*. The *base thread* at the root of this hierarchy has thread number 0.

With multithreading, APL's stack or state indicator can be viewed as a branching tree in which the path from the base to each leaf is a thread.

At any point in time, only one thread is actually running; the others are paused. Each APL thread has its own state indicator, or SI stack. When APL switches from one thread to another, it saves the current stack (with all its local variables and function calls), restores the new one, and then continues processing.

When a parent thread terminates, any of its children which are still running, become the children of (are 'adopted' by) the parent's parent.

Thread numbers are allocated sequentially from 0 to 2147483647. At this point, the sequence 'wraps around' and numbers are allocated from 0 again avoiding any still in use. The sequence is reinitialised when a `)RESET` command is issued, or the active workspace is cleared, or a new workspace is loaded. A workspace may not be saved with threads other than the base thread: 0, running.

Multi-Threading language elements.

The following language elements are provided to support threads.

- Primitive operator, spawn: `&`.
- System functions: `□TID`, `□TCNUMS`, `□TNUMS`, `□TKILL`, `□TSYNC`.
- An extension to the GUI Event syntax to allow asynchronous callbacks.
- A control structure: `:Hold`.
- System commands: `)HOLDS`, `)TID`.
- Extended `)SI` and `)SINL` display.

Running Callback Functions as Threads

A callback function is associated with a particular event via the `Event` property of the object concerned. A callback function is executed by `□DQ` when the event occurs, or by `□NQ`.

If you append the character `&` to the name of the callback function in the `Event` specification, the callback function will be executed asynchronously as a thread when the event occurs. If not, it is executed synchronously as before.

For example, the event specification:

```
□WS'Event' 'Select' 'DoIt&'
```

tells `□DQ` to execute the callback function `DoIt` *asynchronously as a thread* when a `Select` event occurs on the object.

Thread Switching

Programming with threads requires care.

The interpreter may switch between running threads at the following points:

- Between any two lines of a defined function or operator
- On entry to a dfn or dop.
- While waiting for a `□DL` to complete.
- While waiting for a `□FHOLD` to complete.
- While awaiting input from:
 - `□DQ`
 - `□SR`
 - `□ED`
- The session prompt or `□:` or `□`.
- While awaiting the completion of an external operation:
 - A call on an external (AP) function.
 - A call on a `□NA` (DLL) function
 - A call on an OLE function.
 - A call on a .NET function.

At any of these points, the interpreter might execute code in other threads. If such threads change the global environment; for example by changing the value of, or expunging a name; then the changes will appear to have happened while the thread in question passes through the switch point. It is the task of the application programmer to organise and contain such behaviour!

You can prevent threads from interacting in critical sections of code by using the `:Hold` control structure.

High Priority Callback Functions

Note that the interpreter cannot perform thread-switching during the execution of a *high-priority callback*. This is a callback function that is invoked by a *high-priority* event which demands that the interpreter must return a result to Windows before it may process any other event. Such high-priority events include `Configure`, `ExitWindows`, `DateTimeChange`, `DockStart`, `DockCancel`, `DropDown`. It is therefore not permitted to use a `:Hold` control structure in a high-priority callback function.

Name Scope

APL's name scope rules apply whether a function call is synchronous or asynchronous. For example when a defined function is called, names in the calling environment are visible, unless explicitly shadowed in the function header.

Just as with a synchronous call, a function called asynchronously has its own local environment, but can communicate with its parent and "sibling" functions via local names in the parent.

This point is important. It means that siblings can run in parallel without danger of local name clashes. For example, a GUI application can accommodate multiple concurrent instances of its callback functions.

However, with an asynchronous call, as the calling function continues to execute, both child *and parent functions* may modify values in the calling environment. Both functions see such changes immediately they occur.

If a parent function terminates while any of its children are still running, those children will no longer have access to its local names, and references to such names will either generate **VALUE ERROR** or be replaced by values from the environment that called the parent function. If a child function references variables defined by its parent or relies in any other way on its parent's environment (such as a local value of **⌈IO**), the parent function should therefore execute a **⌈TSYNC** in order to wait for its children to complete before itself exiting.

If, on the other hand, after launching an asynchronous child, the parent function calls a *new* function (either synchronously or asynchronously); names in the new function are beyond the purview of the original child. In other words, a function can only ever see its calling stack decrease in size – never increase. This is in order that the parent may call new defined functions without affecting the environment of its asynchronous children.

Stack Considerations

When you start a thread, it begins with the SI stack of the calling function and sees all of the local variables defined in all the functions down the stack. However, unless the calling function specifically waits for the new thread to terminate (see *Language Reference Guide: Wait for Threads to Terminate*), the calling functions will (bit by bit, in their turn) continue to execute. The new thread's view of its calling environment may then change. Consider the following example:

Suppose that you had the following functions: `RUN[3]` calls `INIT` which in turn calls `GETDATA` but as 3 separate threads with 3 different arguments:

```

    ▾ RUN;A;B
[1]  A←1
[2]  B←'Hello World'
[3]  INIT
[4]  CALC
[5]  REPORT
    ▾

    ▾ INIT;C;D
[1]  C←D←0
[2]  GETDATA&'Sales'
[3]  GETDATA&'Costs'
[4]  GETDATA&'Expenses'
    ▾

```

When each `GETDATA` thread starts, it immediately *sees* (via `□SI`) that it was called by `INIT` which was in turn called by `RUN`, and it *sees* local variables `A`, `B`, `C` and `D`. However, once `INIT[4]` has been executed, `INIT` terminates, and execution of the root thread continues by calling `CALC`. From then on, each `GETDATA` thread no longer sees `INIT` (it thinks that it was called directly from `RUN`) nor can it see the local variables `C` and `D` that `INIT` had defined. However, it *does* continue to see the locals `A` and `B` defined by `RUN`, until `RUN` itself terminates.

Note that if `CALC` were also to define locals `A` and `B`, the `GETDATA` threads would still see the values defined by `RUN` and not those defined by `CALC`. However, if `CALC` were to modify `A` and `B` (as globals) without localising them, the `GETDATA` threads would see the modified values of these variables, whatever they happened to be at the time.

Globals and the Order of Execution

It is important to recognise that any reference or assignment to a global or semi-global object (including GUI objects) is **inherently dangerous** (i.e. a source of programming error) if more than one thread is running. Worse still, programming errors of this sort may not become apparent during testing because they are dependent upon random timing differences. Consider the following example:

```

    ▽ BUG; SEMI_GLOBAL
[1] SEMI_GLOBAL←0
[2] FOO← 1
[3] GOO← 1
    ▽

    ▽ FOO
[1] :If SEMI_GLOBAL=0
[2] DO_SOMETHING SEMI_GLOBAL
[3] :Else
[4] DO_SOMETHING_ELSE SEMI_GLOBAL
[5] :EndIf
    ▽

    ▽ GOO
[1] SEMI_GLOBAL←1
    ▽
  
```

In this example, it is formally impossible to predict in which order APL will execute statements in `BUG`, `FOO` or `GOO` from `BUG[2]` onwards. For example, the actual sequence of execution may be:

```

    BUG[1] → BUG[2] → FOO[1] → FOO[2] →
              DO_SOMETHING[1]
  
```

or

```

    BUG[1] → BUG[2] → BUG[3] → GOO[1] →
              FOO[1] → FOO[2] → FOO[3] →
              FOO[4] → DO_SOMETHING_ELSE[1]
  
```

This is because APL may switch from one thread to another between any two lines in a defined function. In practice, because APL gives each thread a significant time-slice, it is likely to execute many lines, maybe even hundreds of lines, in one thread before switching to another. However, you must not rely on this; **thread-switching may occur at any time between lines in a defined function.**

Secondly, consider the possibility that APL switches from the `FOO` thread to the `GOO` thread after `FOO[1]`. If this happens, the value of `SEMI_GLOBAL` passed to `DO_SOMETHING` will be 1 and not 0. Here is another source of error.

In fact, in this case, there are two ways to resolve the problem. To ensure that the value of `SEMI_GLOBAL` remains the same from `FOO[1]` to `FOO[2]`, you may use diamonds instead of separate statements, e.g.

```
:If SEMI_GLOBAL=0 ♦ DO_SOMETHING SEMI_GLOBAL
```

Even better, although less efficient, you may use `:Hold` to synchronise access to the variable, for example:

```

      ▼ FOO
[1]   :Hold 'SEMI_GLOBAL'
[2]   :If SEMI_GLOBAL=0
[3]   DO_SOMETHING SEMI_GLOBAL
[4]   :Else
[5]   DO_SOMETHING_ELSE SEMI_GLOBAL
[6]   :EndIf
[7]   :EndHold
      ▼

      ▼ GOO
[1]   :Hold 'SEMI_GLOBAL'
[2]   SEMI_GLOBAL←1
[3]   :EndHold
      ▼

```

Now, although you still cannot be sure which of `FOO` and `GOO` will run first, you can be sure that `SEMI_GLOBAL` will not change (because `GOO` cuts in) within `FOO`.

Note that the string used as the argument to `:Hold` is completely arbitrary, so long as threads competing for the same resource use the same string.

A Caution

These types of problems are inherent in all multithreading programming languages, and not just with Dyalog APL. *If you want to take advantage of the additional power provided by multithreading, it is advisable to think carefully about the potential interaction between different threads.*

Threads & Niladic Functions

In common with other operators, the spawn operator `&` may accept monadic or dyadic functions as operands, but not niladic functions. This means that, using spawn, you cannot start a thread that consists only of a niladic function

If you wish to invoke a niladic function asynchronously, you have the following choices:

- Turn your niladic function into a monadic function by giving it a dummy argument which it ignores.
- Call your niladic function with a dfn to which you give an argument that is implicitly ignored. For example, if the function `NIL` is niladic, you can call it asynchronously using the expression: `{NIL}& 0`
- Call your function via a dummy monadic function, e.g.

```

[1]  ▽ NIL_M DUMMY
      ▽   NIL
      ▽
      NIL_M& ''

```

- Use `execute`, e.g.

```

&& 'NIL'

```

Note that niladic functions *can* be invoked asynchronously as callback functions. For example, the statement:

```

□WS'Event' 'Select' 'NIL&'

```

will execute correctly as a thread, even though `NIL` is niladic. This is because callback functions are invoked directly by `□DQ` rather than as an operand to the spawn operator.

Threads & External Functions

External functions in dynamic link libraries (DLLs) defined using the `⎕NA` interface may be run in separate C threads. Such threads:

- **take advantage of multiple processors** if the operating system permits.
- allow APL to **continue processing in parallel** during the execution of a `⎕NA` function.

When you define an external function using `⎕NA`, you may specify that the function be run in a separate C thread by appending an ampersand (&) to the function name, for example:

```
'beep'⎕NA'user32|MessageBeep& i'  
A MessageBeep will run in a separate C thread
```

When APL first comes to execute a multi-threaded `⎕NA` function, it starts a new C-thread, executes the function within it, and waits for the result. Other APL threads may then run in parallel.

Note that when the `⎕NA` call finishes and returns its result, its new C-thread is retained to be re-used by any subsequent multithreaded `⎕NA` calls made within the same APL thread. Thus any APL thread that makes any multi-threaded `⎕NA` calls maintains a separate C-thread for their execution. This C-thread is discarded when its APL thread finishes.

Note that there is no point in specifying a `⎕NA` call to be multi-threaded, unless you wish to execute other APL threads at the same time.

In addition, if your `⎕NA` call needs to access an APL GUI object (strictly, a window or other handle) it should normally run within the same C-thread as APL itself, and not in a separate C-thread. This is because Windows associates objects with the C-thread that created them. Although you *can* use a multi-threaded `⎕NA` call to access (say) a Dyalog APL Form via its window handle, the effects may be different than if the `⎕NA` call was not multi-threaded. In general, `⎕NA` calls that access APL (GUI) objects should not be multi-threaded.

If you wish to run the same `⎕NA` call in separate APL threads at the same time, you must ensure that the DLL is *thread-safe*. Functions in DLLs which are not *thread-safe*, must be prevented from running concurrently by using the `:Hold` control structure. Note that all the standard Windows API DLLs **are** *thread safe*.

Notice that you may define two separate functions (with different names), one single-threaded and one multi-threaded, associated with the same function in the DLL. This allows you to call it in either way.

Synchronising Threads

Threads may be synchronised using *tokens* and a *token pool*.

An application can synchronise its threads by having one thread add tokens into the pool whilst other threads wait for tokens to become available and retrieve them from the pool.

Tokens possess two separate attributes, a *type* and a *value*.

The *type* of a token is a positive or negative integer scalar. The *value* of a token is any arbitrary array that you might wish to associate with it.

The token pool may contain up to 2^{*31} tokens; they do not have to be unique neither in terms of their types nor of their values.

The following system functions are used to manage the token pool:

<code>□TPUT</code>	Puts tokens into the pool.
<code>□TGET</code>	If necessary waits for, and then retrieves some tokens from the pool.
<code>□TPOOL</code>	Reports the types of tokens in the pool
<code>□TREQ</code>	Reports the token requests from specific threads

A simple example of a thread synchronisation requirement occurs when you want one thread to reach a certain point in processing before a second thread can continue. Perhaps the first thread performs a calculation, and the second thread must wait until the result is available before it can be used.

This can be achieved by having the first thread put a specific type of token into the pool using `□TPUT`. The second thread waits (if necessary) for the new value to be available by calling `□TGET` with the same token type.

Notice that when `□TGET` returns, the specified tokens are *removed* from the pool. However, *negative* token types will satisfy an infinite number of requests for their positive equivalents.

The system is designed to cater for more complex forms of synchronisation. For example, a *semaphore* to control a number of resources can be implemented by keeping that number of tokens in the pool. Each thread will take a token while processing, and return it to the pool when it has finished.

A second complex example is that of a *latch* which holds back a number of threads until the coast is clear. At a signal from another thread, the latch is opened so that all of the threads are released. The latch may (or may not) then be closed again to hold up subsequently arriving threads. A practical example of a latch is a ferry terminal.

Semaphore Example

A *semaphore* to control a number of resources can be implemented by keeping that number of tokens in the pool. Each thread will take a token while processing, and return it to the pool when it has finished.

For example, if we want to restrict the number of threads that can have sockets open at any one time.

```

    sock+99
    TPUT 5/sock
pool.
    ▽ sock_open ...
[1]   :If sock=TGET sock
[.]   ...
[.]   TPUT sock
[.]   :Else
[.]   error'sockets off'
[.]   :EndIf
    ▽
    0 TPUT treq tnums

```

A socket-token
any +ive number will do).
A add 5 socket-tokens to

A grab a socket token
A do stuff.
A release socket token
A sockets switched off by
retract (see below).

A retract socket "service"
with 0 value.

Latch Example

A *latch* holds back a number of threads until the coast is clear. At a signal from another thread, the latch is opened so that all of the threads are released. The latch may (or may not) then be closed again to hold up subsequently arriving threads.

A visual example of a latch might be a ferry terminal, where cars accumulate in the queue until the ferry arrives. The barrier is then opened and all (up to a maximum number) of the cars are allowed through it and on to the ferry. When the last car is through, the barrier is re-closed.

```

    tkt←6                                A 6-token: ferry
ticket.

    ▽ car ...
[1]   □TGET tkt                          A await ferry.
[2]   ...

    ▽ ferry ...
[1]   arrives in port
[2]   □TPUT(†,/□treq □tnums)ntkt  A ferry tickets for
all.
[3]   ...

```

Note that it is easy to modify this example to provide a maximum number of ferry places per trip by inserting `max_places†` between `□TPUT` and its argument. If fewer cars than the ferry capacity are waiting, the `†` will fill with trailing 0s. This will not cause problems because zero tokens are ignored.

Let us replace the car ferry with a new road bridge. Once the bridge is ready for traffic, the barrier could be opened permanently by putting a *negative* ticket in the pool.

```
□TPUT -tkt      A open ferry barrier permanently.
```

Cars could choose to take the last ferry if there are places:

```

    ▽ car ...
[1]   :Select □TGET tkt
[2]   :Case tkt ◊ take the last ferry.
[3]   :Case -tkt ◊ ferry full: take the new bridge.
[4]   :End

```

The above `:Select` works because by default, `□TPUT -tkt` puts a *value* of `-tkt` into the token.

Debugging Threads

If a thread sustains an untrapped error, its execution is *suspended* in the normal way. If the *Pause on Error* option is set, all other threads are *paused*. If *Pause on Error* option is not set, other threads will continue running and it is possible for another thread to encounter an error and suspend (see the *Dyalog for Microsoft Windows Installation and Configuration Guide*).

Using the facilities provided by the Tracer and the Threads Tool (see the *Dyalog for Microsoft Windows UI Guide*) it is possible to interrupt (suspend) and restart individual threads, and to pause and resume individual threads, so any thread may be in one of three states - *running*, *suspended* or *paused*.

The Tracer and the Session may be connected with any suspended thread and you can switch the attention of the Session and the Tracer between suspended threads using `)TID` or by clicking on the appropriate tab in the Tracer. At this point, you may:

- Examine and modify local variables for the currently suspended thread.
- Trace and edit functions in the current thread.
- Cut back the stack in the currently suspended thread.
- Restart execution.
- Start new threads

The error message from a thread other than the base is prefixed with its thread number:

```
260:DOMAIN ERROR
Div[2] rslt←num÷div
  ^
```

State indicator displays: `)SI` and `)SINL` have been extended to show threads' tree-like calling structure.

```
      )SI
·     #.Calc[1]
&5
·     ·     #.DivSub[1]
·     &7
·     ·     #.DivSub[1]
·     &6
·     #.Div[2]*
&4
#.Sub[3]
#.Main[4]
```

Here, `Main` has called `Sub`, which has spawned threads `4` and `5` with functions: `Div` and `Calc`. Function `Div`, after spawning `DivSub` in each of threads `6` and `7`, have been suspended at line `[2]`.

Removing stack frames using *Quit* from the Tracer or \rightarrow from the session affects only the current thread. When the final stack frame in a thread (other than the base thread) is removed, the thread is expunged.

)RESET removes all but the base thread.

Note the distinction between a *suspended* thread and a *paused* thread.

A *suspended* thread is stopped at the beginning of a line in a defined function or operator. It may be connected to the Session so that expressions executed in the Session do so in the context of that thread. It may be *restarted* by executing \rightarrow **line** (typically, \rightarrow **LC**).

A *paused* thread is an inactive thread that is currently being ignored by the thread scheduler. A paused thread may be paused within a call to **DDQ**, a call on an external function, at the beginning of a line, or indeed at any of the thread-switching points described earlier in this chapter.

A paused thread may be *resumed* only by the action of a menu item or button. A paused thread resumes only in the sense that it ceases to be ignored by the thread scheduler and will therefore be switched back to at some point in the future. It does not actually continue executing until the switch occurs.

External Variables

An external variable is a variable whose contents (value) reside not in the workspace, but in a file. An external variable is associated with a file by the system function `⊞XT`. If at the time of association the file exists, the external variable assumes its value from the contents of the file. If the file does not exist, the external variable is defined but a **VALUE ERROR** occurs if it is referenced before assignment.

Assignment of an array to the external variable or to an indexed element of the external variable has the effect of updating the file. The value of the external variable or the value of indexed elements of the external variable is made available in the workspace when the external variable occurs in an expression. No special restrictions are placed on the usage of external variables.

Normally, the files associated with external variables remain permanent in that they survive the APL session or the erasing of the external variable from the workspace. External variables may be accessed concurrently by several users, or by different nodes on a network, provided that the appropriate file access controls are established. Multi-user access to an external variable may be controlled with the system function `⊞FHOLD` between co-operating tasks.

Refer to the sections describing the system functions `⊞XT` and `⊞FHOLD` in *Chapter 6* for further details.

Examples

```

      'ARRAY' ⊞XT 'V'

      V←ι10
      V[2] + 5
7

      ⊞EX'V'

      'ARRAY' ⊞XT 'F'
      F
1 2 3 4 5 6 7 8 9 10

```

Component Files

A component file is a data file maintained by Dyalog APL. It contains a series of APL arrays known as components which are accessed by reference to their relative positions or component number within the file. A set of system functions is provided to perform a range of file operations. (See *Language Reference Guide: Component Files*.) These provide facilities to create or delete files, and to read and write components. Facilities are also provided for multi-user access including the capability to determine who may do what, and file locking for concurrent updates. (See the *Dyalog Programming Reference Guide*).

Auxiliary Processors

Auxiliary Processors (APs) are non-APL programs which provide Dyalog APL users with additional facilities. They run as separate tasks, and communicate with the Dyalog APL interpreter through pipes (UNIX) or via an area of memory (Windows). Typically, APs are used where speed of execution is critical, such as in screen management software, or for utility libraries. Auxiliary Processors may be written in any compiled language, although 'C' is preferred and is directly supported.

When an Auxiliary Processor is invoked from Dyalog APL, one or more *external functions* are fixed in the active workspace. Each external function behaves as if it was a locked defined function, but is in effect an entry point into the Auxiliary Processor. An external function occupies only a negligible amount of workspace.

Although Auxiliary Processors are still supported, Dyalog recommends that DLLs/shared libraries, called via the [DNA](#) interface should be used on all platforms in future, and that existing APs are converted to DLLs/shared libraries.

Key to Notation

The following definitions and conventions apply throughout this manual:

f	A function, or an operator's left operand (function or array).
g	A function, or an operator's right operand (function or array).
A	An operator's left argument when an array.
B	An operator's right argument when an array.
X	The left argument of a function.
Y	The right argument of a function.
R	The explicit result of a function.
[K]	Axis specification.
[I]	Index specification.
{X}	The left argument of a function is optional.
{R}←	The function may or may not return a result, or the result may be suppressed.

function may refer to a primitive function, a system function, a defined (canonical, dfn or assigned) function or a derived (from an operator) function.

Migration Level

ML determines the degree of migration of the Dyalog APL language towards IBM's APL2. Unless otherwise stated, the manual assumes **ML** has a value of 1.

Chapter 2:

Defined Functions & Operators

A defined function is a program that takes 0, 1, or 2 arrays as **arguments** and may produce an array as a result. A defined operator is a program that takes 1 or 2 functions or arrays (known as **operands**) and produces a **derived function** as a result. To simplify the text, the term **operation** is used within this chapter to mean function or operator.

Canonical Representation

Operations may be defined with the system function `⍶FX` (Fix) or by using the editor within definition mode. Applying `⍶CR` to the character array representing the name of an already established operation will produce its canonical representation. A defined operation is composed of lines. The first line (line 0) is called the operation HEADER. Remaining lines are APL statements, called the BODY.

The operation header consists of the following parts:

1. its model syntactical form,
2. an optional list of local names, each preceded by a semi-colon (;) character,
3. an optional comment, preceded by the symbol `⍷`.

Only the model is required. If local names and comments are included, they must appear in the prescribed order.

Model Syntax

The model for the defined operation identifies the name of the operation, its valence, and whether or not an explicit result may be returned. Valence is the number of explicit arguments or operands, either 0, 1 or 2; whence the operation is termed NILADIC, MONADIC or DYADIC respectively. Only a defined function may be niladic. There is no relationship between the valence of a defined operator, and the valence of the derived function which it produces. Defined functions and derived functions produced by defined operators may be ambivalent, i.e. may be executed monadically with one argument, or dyadically with two. An ambivalent operation is identified in its model by enclosing the left argument in braces.

The value of a result-returning function or derived function may be suppressed in execution if not explicitly used or assigned by enclosing the result in its model within braces. Such a suppressed result is termed SHY.

The tables below show all possible models for defined functions and operators respectively.

Defined Functions

Result	Niladic	Monadic	Dyadic	Ambivalent
None	f	$f Y$	$X f Y$	$\{X\} f Y$
Explicit	$R \leftarrow f$	$R \leftarrow f Y$	$R \leftarrow X f Y$	$R \leftarrow \{X\} f Y$
Suppressed	$\{R\} \leftarrow f$	$\{R\} \leftarrow f Y$	$\{R\} \leftarrow X f Y$	$\{R\} \leftarrow \{X\} f Y$

Note: the right argument Y and/or the result R may be represented by a single name, or as a blank-delimited list of names surrounded by parentheses. For further details, see [Namelists on page 83](#).

Derived Functions produced by Monadic Operator

Result	Monadic	Dyadic	Ambivalent
None	$(A \text{ op}) Y$	$X (A \text{ op}) Y$	$\{X\} (A \text{ op}) Y$
Explicit	$R \leftarrow (A \text{ op}) Y$	$R \leftarrow X (A \text{ op}) Y$	$R \leftarrow \{X\} (A \text{ op}) Y$
Suppressed	$\{R\} \leftarrow (A \text{ op}) Y$	$\{R\} \leftarrow X (A \text{ op}) Y$	$\{R\} \leftarrow \{X\} (A \text{ op}) Y$

Derived Functions produced by Dyadic Operator

Result	Monadic	Dyadic	Ambivalent
None	$(A \text{ op } B)Y$	$X(A \text{ op } B)Y$	$\{X\}(A \text{ op } B)Y$
Explicit	$R \leftarrow (A \text{ op } B)Y$	$R \leftarrow X(A \text{ op } B)Y$	$R \leftarrow \{X\}(A \text{ op } B)Y$
Suppressed	$\{R\} \leftarrow (A \text{ op } B)Y$	$\{R\} \leftarrow X(A \text{ op } B)Y$	$\{R\} \leftarrow \{X\}(A \text{ op } B)Y$

Statements

A statement is a line of characters understood by APL. It may be composed of:

1. a LABEL (which must be followed by a colon `:`), or a CONTROL STATEMENT (which is preceded by a colon), or both,
2. an EXPRESSION (see [Expressions on page 18](#)),
3. a SEPARATOR (consisting of the diamond character `⋄` which must separate adjacent expressions),
4. a COMMENT (which must start with the character `Ⓐ`).

Each of the four parts is optional, but if present they must occur in the given order except that successive expressions must be separated by `⋄`. Any characters occurring to the right of the first comment symbol (`Ⓐ`) that is not within quotes is a comment.

Comments are not executed by APL. Expressions in a line separated by `⋄` are taken in left-to-right order as they occur in the line. For output display purposes, each separated expression is treated as a separate statement.

Examples

```
50      5×10
```

```
50      MULT: 5×10
```

```
50      MULT: 5×10 ⋄ 2×4
8
```

```
50      MULT: 5×10 ⋄ 2×4 Ⓐ MULTIPLICATION
8
```

Global & Local Names

The following names, if present, are local to the defined operation:

1. the result,
2. the argument(s) and operand(s),
3. additional names in the header line following the model, each name preceded by a semi-colon character,
4. labels,
5. the argument list of the system function `⊞SHADOW` when executed,
6. a name assigned within a dfn.

All names in a defined operation must be valid APL names. The same name may be repeated in the header line, including the operation name (whence the name is localised). Normally, the operation name is not a local name.

The same name may not be given to both arguments or operands of a dyadic operation. The name of a label may be the same as a name in the header line. More than one label may have the same name. When the operation is executed, local names in the header line after the model are initially undefined; labels are assigned the values of line numbers on which they occur, taken in order from the last line to the first; the result (if any) is initially undefined.

In the case of a defined function, the left argument (if any) takes the value of the array to the left of the function when called; and the right argument (if any) takes the value of the array to the right of the function when called. In the case of a defined operator, the left operand takes the value of the function or array to the left of the operator when called; and the right operand (if any) takes the value of the function or array to the right of the operator when called.

During execution, a local name temporarily excludes from use an object of the same name with an active definition. This is known as LOCALISATION or SHADOWING. A value or meaning given to a local name will persist only for the duration of execution of the defined operation (including any time whilst the operation is halted). A name which is not local to the operation is said to be GLOBAL. A global name could itself be local to a pending operation. A global name can be made local to a defined operation during execution by use of the system function `⊞SHADOW`. An object is said to be VISIBLE if there is a definition associated with its name in the active environment.

Examples

```

      A←1
    ▽ F
[1]   A←10
[2]   ▽

      F R <A> NOT LOCALISED IN <F>, GLOBAL VALUE REPLACED
      A
10
      A←1
      )ERASE F

    ▽ F;A
[1]   A←10
[2]   ▽

      F R <A> LOCALISED IN <F>, GLOBAL VALUE RETAINED
      A
1

```

Any statement line in the body of a defined operation may begin with a LABEL. A label is followed by a colon (:). A label is a constant whose value is the number of the line in the operation defined by system function `⊞FX` or on closing definition mode.

The value of a label is available on entering an operation when executed, and it may be used but not altered in any expression.

Example

```

      ⊞VR 'PLUS'
    ▽ R←{A} PLUS B
[1]   →DYADIC ρ~2=⊞NC'A' ⋄ R←B ⋄ →END
[2]   DYADIC: R←A+B
[3]   END:
    ▽

      1 ⊞STOP'PLUS'

      2 PLUS 2

PLUS[1]
      DYADIC
2

      END
3

```

Locals Lines

Locals Lines are lines in a defined function or operator that serve only to define local names.

A *Locals Line* may appear anywhere between line [0] and the first executable statement in the function or operator. *Locals lines* may be interspersed with blank lines and comments. A *Locals Line* is identified by starting with a semicolon, prefixed optionally by whitespace. It may contain a comment at the end.

A *Locals Line* must be of the form `;name;name;name` where `name` is any valid APL name or localisable system variable. The names are localised on entry to the function exactly as if they were specified as locals on line [0].

Example

```

▽ r←foo y;a;b           A some locals
    ;c;d               A some more locals
  (a b c d)←y
  r←a+b-c×d
▽

```

The function `foo` shown above localises names `a`, `b`, `c` and `d` (the indentation on line [1] in this example is entirely optional)

Syntactical errors on *Locals Lines* are detected when the user attempts to fix the function using the Editor or `FX` and will causes the operation to fail.

Namelists

The right argument and the result of a function may be specified in the function header by a single name or by a *Namelist*. In this context, a Namelist is a blank-delimited list of names surrounded by a single set of parentheses.

Names specified in a Namelist are automatically local to the function; there is no need to localise them explicitly using semi-colons.

If the *right argument* of a function is declared as a Namelist, the function will only accept a right argument that is a vector whose length is the same as the number of names in the Namelist. Calling the function with any other argument will result in a **LENGTH ERROR** in the calling statement. Otherwise, the elements of the argument are assigned to the names in the Namelist in the specified order.

Example:

```

▽ IDN←Date2IDN(Year Month Day)
[1] 'Year is ',⌘Year
[2] 'Month is ',⌘Month
[3] 'Day is ',⌘Day
[4] ...
▽

Date2IDN 2004 4 30
Year is 2004
Month is 4
Day is 30

Date2IDN 2004 4
LENGTH ERROR
Date2IDN 2004 4
^

```

Note that if you specify a *single* name in the Namelist, the function may be called only with a 1-element vector right argument. If the *result* of a function is declared as a Namelist, the values of the names will automatically be stranded together in the specified order and returned as the result of the function when the function terminates.

Example:

```

▽ (Year Month Day)←Birthday age
[1] Year←1949+age
[2] Month←4
[3] Day←30
▽
Birthday 50
1999 4 30

```

Function Declaration Statements

Function Declaration statements are used to identify the characteristics of a function in some way.

The following declarative statements are provided.

- [:Access](#)
- [:Attribute](#)
- [:Implements](#)
- [:Signature](#)

With one exception, these statements are not executable statements and may theoretically appear anywhere in the body of the function. However, it is recommended that you place them at the beginning before any executable statements. The exception is:

`:Implements Constructor <[:Base expr]>`

In addition to being declarative (declaring the function to be a Constructor) this statement also executes the Constructor in the Base Class whether or not it includes :Base expr. Its position in the code is therefore significant.

Access Statement**: Access**

```
:Access <Private|Public><Instance|Shared>
:Access <WebMethod>
```

The **:Access** statement is used to specify characteristics for functions that represent Methods in classes (see [Methods on page 185](#)). It is also applicable to Classes and Properties.

Element	Description
Private Public	Specifies whether or not the method is accessible from outside the Class or an Instance of the Class. The default is Private .
Instance Shared	Specifies whether the method runs in the Class or Instance. The default is Instance .
WebMethod	Specifies that the method is exported as a web method. This applies only to a Class that implements a Web Service.
Overridable	Applies only to an Instance Method and specifies that the Method may be overridden by a Method in a higher Class. See below.
Override	Applies only to an Instance Method and specifies that the Method overrides the corresponding Overridable Method defined in the Base Class. See below

Overridable/Override

Normally, a Method defined in a higher Class replaces a Method of the same name that is defined in its Base Class, but only for calls made from above or within the higher Class itself (or an Instance of the higher Class). The base method remains available *in the Base Class* and is invoked by a reference to it *from within the Base Class*.

However, a Method declared as being **Overridable** is replaced in-situ (i.e. within its own Class) by a Method of the same name in a higher Class if that Method is itself declared with the **Override** keyword. For further information, see [Superseding Base Class Methods on page 188](#).

WebMethod

Note that `:Access WebMethod` is equivalent to:

```
:Access Public
:Attribute System.Web.Services.WebMethodAttribute
```

Attribute Statement

:Attribute

```
:Attribute <Name> [ConstructorArgs]
```

The `:Attribute` statement is used to attach .NET Attributes to a Method (or Class).

Attributes are descriptive tags that provide additional information about programming elements. Attributes are not used by Dyalog APL but other applications can refer to the extra information in attributes to determine how these items can be used. Attributes are saved with the *metadata* of Dyalog APL .NET assemblies.

Element	Description
<code>Name</code>	The name of a .NET attribute
<code>ConstructorArgs</code>	Optional arguments for the Attribute constructor

Examples

```
:Attribute ObsoleteAttribute
:Attribute ObsoleteAttribute 'Don't use' 1
```

Implements Statement**: Implements**

The `:Implements` statement identifies the function to be one of the following types.

```
:Implements Constructor <[:Base expr]>
:Implements Destructor
:Implements Method <InterfaceName.MethodName>
:Implements Trigger <name1><,name2,name3,...>
:Implements Trigger *
```

Element	Description
<code>Constructor</code>	Specifies that the function is a Class Constructor .
<code>:Base expr</code>	Specifies that the Base Constructor be called with the result of the expression <code>expr</code> as its argument.
<code>Destructor</code>	Specifies that the function is a Class Destructor .
<code>Method</code>	Specifies that the function implements the Method <code>MethodName</code> whose syntax is specified by Interface InterfaceName .
<code>Trigger</code>	Identifies the function as a Trigger Function which is activated by changes to variable <code>name1</code> , <code>name2</code> , and so forth. Trigger * specifies a Global Trigger that is activated by the assignment of any global variable in the same namespace.

Signature Statement**:Signature**

```
:Signature <rslttype<-><name><arg1type arg1name>,...
```

This statement identifies the name and signature by which a function is exported as a method to be called from outside Dyalog APL. Several **:Signature** statements may be specified to allow the method to be called with different arguments and/or to specify a different result type.

Element	Description
rslttype	Specifies the data type for the result of the method
name	Specifies the name of the exported method.
argntype	Specifies the data type of the nth parameter
argnname	Specifies the name of the nth parameter

Argument and result data types are identified by the names of .NET Types which are defined in the .NET Assemblies specified by **⎕USING** or by a **:USING** statement.

Examples

In the following examples, it is assumed that the .NET Search Path (defined by **:Using** or **⎕USING** includes 'System'.

The following statement specifies that the function is exported as a method named **Format** which takes a single parameter of type **System.Object** named **Array**. The data type of the result of the method is an array (vector) of type **System.String**.

```
:Signature String[]←Format Object Array
```

The next statement specifies that the function is exported as a method named **Catenate** whose result is of type **System.Object** and which takes 3 parameters. The first parameter is of type **System.Double** and is named **Dimension**. The second is of type **System.Object** and is named **Arg1**. The third is of type **System.Object** and is named **Arg2**.

```
:Signature Object←Catenate Double Dimension,...
...Object Arg1, Object Arg2
```

The next statement specifies that the function is exported as a method named `IndexGen` whose result is an array of type `System.Int32` and which takes 2 parameters. The first parameter is of type `System.Int32` and is named `N`. The second is of type `System.Int32` and is named `Origin`.

```
:Signature Int32[]←IndexGen Int32 N, Int32 Origin
```

The next block of statements specifies that the function is exported as a method named `Mix`. The method has 4 different signatures; i.e. it may be called with 4 different parameter/result combinations.

```
:Signature Int32[,]←Mix Double Dimension, ...  
    ...Int32[] Vec1, Int32[] Vec2  
:Signature Int32[,]←Mix Double Dimension,...  
    ... Int32[] Vec1, Int32[] Vec2, Int32 Vec3  
:Signature Double[,]←Mix Double Dimension, ...  
    ... Double[] Vec1, Double[] Vec2  
:Signature Double[,]←Mix Double Dimension, ...  
    ... Double[] Vec1, Double[] Vec2, Double[]  
Vec3
```

Control Structures

Control structures provide a means to control the flow of execution in your APL programs.

Traditionally, lines of APL code are executed one by one from top to bottom and the only way to alter the flow of execution is using the branch arrow. So how do you handle logical operations of the form “If this, do that; otherwise do the other”?

In APL this is often not a problem because many logical operations are easily performed using the standard array handling facilities that are absent in other languages. For example, the expression:

```
STATUS←(1+AGE<16)>'Adult' 'Minor'
```

sets `STATUS` to `'Adult'` if `AGE` is 16 or more; otherwise sets `STATUS` to `'Minor'`.

Things become trickier if, depending upon some condition, you wish to execute one set of code instead of another, especially when the code fragments cannot conveniently be packaged as functions. Nevertheless, careful use of array logic, defined operators, the execute primitive function and the branch arrow can produce high quality maintainable and comprehensible APL systems.

Control structures provide an additional mechanism for handling logical operations and decisions. Apart from providing greater affinity with more traditional languages, Control structures may enhance comprehension and reduce programming errors, especially when the logic is complex. Control structures are not, however, a replacement for the standard logical array operations that are so much a part of the APL language.

Control Structures are blocks of code in which the execution of APL statements follows certain rules and conditions. Control structures are implemented using a set of *control words* that all start with the colon symbol (:). Control Words are case-insensitive.

There are nine different types of control structures defined by the control words, `:If`, `:While`, `:Repeat`, `:For` (with the supplementary control words `:In` and `:InEach`), `:Select`, `:With`, `:Trap`, `:Hold` and `:Disposable`. Each one of these control words may occur only at the beginning of an APL statement and indicates the start of a particular type of control structure.

Within a control structure, certain other control words are used as qualifiers. These are `:Else`, `:ElseIf`, `:AndIf`, `:OrIf`, `:Until`, `:Case` and `:CaseList`.

A third set of control words is used to identify the end of a particular control structure. These are `:EndIf`, `:EndWhile`, `:EndRepeat`, `:EndFor`, `:EndSelect`, `:EndWith`, `:EndTrap`, `:EndHold` and `:EndDisposable`. Although formally distinct, these control words may all be abbreviated to `:End`.

Finally, the `:GoTo`, `:Return`, `:Leave` and `:Continue` control words may be used to conditionally alter the flow of execution within a control structure.

Control words, including qualifiers such as `:Else` and `:ElseIf`, may occur only at the beginning of a line or expression in a diamond-separated statement. The only exceptions are `:In` and `:InEach` which must appear on the same line within a `:For` expression.

Key to Notation

The following notation is used to describe Control Structures within this section:

<code>aexp</code>	an expression returning an array,
<code>bexp</code>	an expression returning a single Boolean value (0 or 1),
<code>var</code>	loop variable used by <code>:For</code> control structure,
<code>code</code>	0 or more lines of APL code, including other (nested) control structures,
<code>andor</code>	<p><i>either</i> one or more <code>:AndIf</code> statements, <i>or</i> one or more <code>:OrIf</code> statements. For further details, see below.</p>

Notes

Code preceding `:OrIf` and `:AndIf`

Code that precedes a `:OrIf` control statement, e.g. code placed between a `:If` statement and a subsequent `:OrIf`, will be executed only if the outer condition is false. If instead the outer condition is true, there is no need to execute the `:OrIf` statement, so it and any preceding lines of code are skipped.

Code that precedes a `:AndIf` control statement, e.g. code placed between a `:If` statement and a subsequent `:AndIf`, will only be executed if the outer condition is true. If instead the outer condition is false, there is no need to execute the `:AndIf` statement, so it and any preceding lines of code are skipped.

The above behaviour may be examined using the Tracer.

A potential use for code before a `:OrIf` or `:AndIf` is to prepare for the conditional test. This preparatory work will only be done if required. For example:

```
:If x      A if x is false, skip everything up to the :EndIf
      y←..A set up stuff for the condition on the next line
      :AndIf y
          do stuff
:EndIf
```

Warning

With the exception of a diamondised statement, a control statement that should **not** be followed by an expression will generate an error if an expression is supplied.

A line in a function consisting of a control statement followed by a `◇` and subsequent expression(s) is not **currently** disallowed but may exhibit unexpected behaviour. In particular, the line will not honour `□STOP` and will not be metered by `□MONITOR`. This syntax is not recommended.

Access Statement**:Access**

The **:Access** statement may be used to define the characteristics of a Class, the characteristics of a defined function (Method) in a Class, or the characteristics of other Class members.

[:Access Statement in a Function/Method.](#)

[:Access Statement in a Class or in other members of a Class.](#)

Attribute Statement**:Attribute**

The **:Attribute** statement is used to attach .NET Attributes to a Method or a Class.

[:Attribute Statement for a Class.](#)

[:Attribute statement for a Method.](#)

If Statement

:If bexp

The simplest **:If** control structure is a single condition of the form:

```
[1] :If AGE<21
[2]     expr 1
[3]     expr 2
[5] :EndIf
```

If the test condition (in this case **AGE<21**) is true, the statements between the **:If** and the **:EndIf** will be executed. If the condition is false, none of these statements will be run and execution resumes after the **:EndIf**. Note that the test condition to the right of **:If** must return a single element Boolean value 1 (true) or 0 (false).

:If control structures may be considerably more complex. For example, the following code will execute the statements on lines [2-3] if **AGE<21** is 1 (true), **or alternatively**, the statement on line [6] if **AGE<21** is 0 (false).

```
[1] :If AGE<21
[2]     expr 1
[3]     expr 2
[5] :Else
[6]     expr 3
[7] :EndIf
```

Instead of a single condition, it is possible to have multiple conditions using the **:ElseIf** control word. For example:

```
[1] :If WINEAGE<5
[2]     'Too young to drink'
[5] :ElseIf WINEAGE<10
[6]     'Just Right'
[7] :ElseIf WINEAGE<15
[8]     'A bit past its prime'
[9] :Else
[10]    'Definitely over the hill'
[11] :EndIf
```

Notice that APL executes the expression(s) associated with the **first** condition that is true or those following the **:Else** if **none** of the conditions are true.

The `:AndIf` and `:OrIf` control words may be used to define a block of conditions and so refine the logic still further. You may qualify an `:If` or an `:ElseIf` with one or more `:AndIf` statements **or** with one or more `:OrIf` statements. You may not however mix `:AndIf` and `:OrIf` in the same conditional block. For example:

```
[1]   :If WINE.NAME≡'Chateau Lafitte'  
[2]   :AndIf WINE.YEAR∈1962 1967 1970  
[3]       'The greatest?'  
[4]   :ElseIf WINE.NAME≡'Chateau Latour'  
[5]   :Orif WINE.NAME≡'Chateau Margaux'  
[6]   :Orif WINE.PRICE>100  
[7]       'Almost as good'  
[8]   :Else  
  
[9]       'Everyday stuff'  
[10]  :EndIf
```

Please note that in a `:If` control structure, the conditions associated with each of the condition blocks are executed in order until an entire condition block evaluates to true. At that point, the APL statements following this condition block are executed. None of the conditions associated with any other condition block are executed. Furthermore, if an `:AndIf` condition yields 0 (false), it means that the entire block must evaluate to false so the system moves immediately on to the next block without executing the other conditions following the failing `:AndIf`. Likewise, if an `:OrIf` condition yields 1 (true), the entire block is at that point deemed to yield true and none of the following `:OrIf` conditions in the same block are executed.

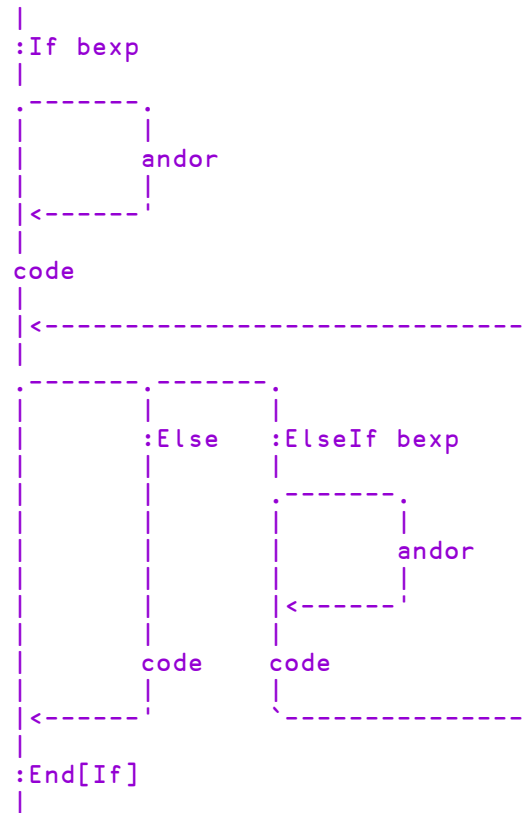
:If Statement

While Statement

:While bexp

The simplest **:While** loop is :

```
[1]  I←0
[2]  :While I<100
[3]      expr1
[4]      expr2
[5]      I←I+1
[6]  :EndWhile
```

Unless **expr1** or **expr2** alter the value of **I**, the above code will execute lines [3-4] 100 times. This loop has a single condition; the value of **I**. The purpose of the **:EndWhile** statement is solely to mark the end of the iteration. It acts the same as if it were a branch statement, branching back to the **:While** line.

An alternative way to terminate a **:While** structure is to use a **:Until** statement. This allows you to add a second condition. The following example reads a native file sequentially as 80-byte records until it finds one starting with the string 'Widget' or reaches the end of the file.

```
[1]  I←0
[2]  :While I<[]NSIZE -1
[3]      REC←[]NREAD -1 82 80
[4]      I←I+pREC
[5]  :Until 'Widget'≡6pREC
```

Instead of single conditions, the tests at the beginning and end of the loop may be defined by more complex ones using **:AndIf** and **:OrIf**. For example:

```
[1]  :While 100>i
[2]  :AndIf 100>j
[3]      i j←foo i j
[4]  :Until 100<i+j
[5]  :OrIf i<0
[6]  :OrIf j<0
```

In this example, there are complex conditions at both the start and the end of the iteration. Each time around the loop, the system tests that both **i** and **j** are less than or equal to 100. If either test fails, the iteration stops. Then, after **i** and **j** have been recalculated by **foo**, the iteration stops if **i+j** is equal to or greater than 100, or if either **i** or **j** is negative.

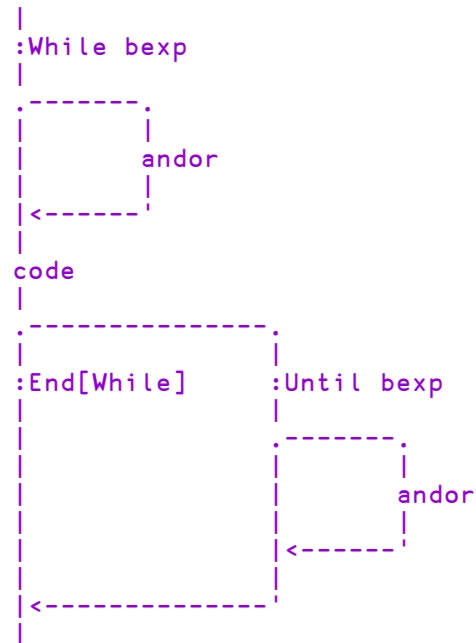
:While Statement

Repeat Statement

:Repeat

The simplest type of **:Repeat** loop is as follows. This example executes lines [3-5] 100 times. Notice that as there is no conditional test at the beginning of a **:Repeat** structure, its code statements are executed at least once.

```
[1]   I←0
[2]   :Repeat
[3]       expr1
[4]       expr2
[5]       I←I+1
[6]   :Until I=100
```

You can have multiple conditional tests at the end of the loop by adding **:AndIf** or **:OrIf** expressions. The following example will read data from a native file as 80-character records until it reaches one beginning with the text string 'Widget' or reaches the end of the file.

```
[1]   :Repeat
[2]       REC←NREAD ^1 82 80
[3]   :Until 'Widget'≡6pREC
[4]   :OrIf 0=pREC
```

A **:Repeat** structure may be terminated by an **:EndRepeat** (or **:End**) statement in place of a conditional expression. If so, your code must explicitly jump out of the loop using a **:Leave** statement or by branching. For example:

```
[1]   :Repeat
[2]       REC←NREAD ^1 82 80
[3]       :If 0=pREC
[4]       :OrIf 'Widget'≡6pREC
[5]           :Leave
[6]       :EndIf
[7]   :EndRepeat
```

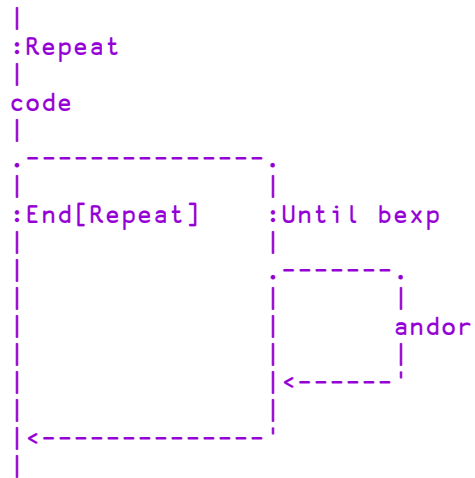
:Repeat Statement

For Statement :For var :In[Each] aexp

Single Control Variable

The `:For` loop is used to execute a block of code for a series of values of a particular control variable. For example, the following would execute lines [2-3] successively for values of `I` from 3 to 5 inclusive:

```
[1]   :For I :In 3 4 5
[2]       expr1 I
[3]       expr2 I
[4]   :EndFor
```

The way a `:For` loop operates is as follows. On encountering the `:For`, the expression to the right of `:In` is evaluated and the result stored. This is the *control array*. The *control variable*, named to the right of the `:For`, is then assigned the first value in the control array, and the code between `:For` and `:EndFor` is executed. On encountering the `:EndFor`, the control variable is assigned the next value of the control array and execution of the code is performed again, starting at the first line after the `:For`. This process is repeated for each value in the control array.

Note that if the control array is empty, the code in the `:For` structure is not executed. Note too that the control array may be any rank and shape, but that its elements are assigned to the control variable in ravel order.

The control array may contain any type of data. For example, the following code resizes (and compacts) all your component files

```
[1]   :For FILE :In (↓FLIB '')~'' '
[2]       FILE FTIE 1
[3]       FRESIZE 1
[4]       FUNTIE 1
[5]   :EndFor
```

You may also nest `:For` loops. For example, the following expression finds the timestamp of the most recently updated component in all your component files.

```
[1]   TS←0
[2]   :For FILE :In (↓FLIB '')~'' '
[3]       FILE FTIE 1
[4]       START END←2pFSIZE 1
[5]       :For COMP :In (START-1)↓END-1
[6]           TS[←-1↑FREAD FILE COMP
[7]       :EndFor
[8]       FUNTIE 1
[9]   :EndFor
```

Multiple Control Variables

The `:For` control structure can also take multiple variables. This has the effect of doing a strand assignment each time around the loop.

For example `:For a b c :in (1 2 3)(4 5 6)`, sets `a b c←1 2 3`, first time around the loop and `a b c←4 5 6`, the second time.

Another example is `:For i j :In ipMatrix`, which sets `i` and `j` to each row and column index of `Matrix`.

:InEach Control Word

```
:For var ... :InEach value ...
```

In a `:For` control structure, the keyword `:InEach` is an alternative to `:In`.

For a single control variable, the effect of the keywords is identical but for multiple control variables the values vector is inverted.

The distinction is best illustrated by the following equivalent examples:

```
:For a b c :In (1 2 3)(3 4 5)(5 6 7)(7 8 9)
  □←a b c
:EndFor

:For a b c :InEach (1 3 5 7)(2 4 6 8)(3 5 7 9)
  □←a b c
:EndFor
```

In each case, the output from the loop is:

```
1 2 3
3 4 5
5 6 7
7 8 9
```

Notice that in the second case, the number of items in the values vector is the same as the number of control variables. A more typical example might be.

```
:For a b c :InEach aVec bVec cVec
  ...
:EndFor
```

Here, each time around the loop, control variable `a` is set to the next item of `aVec`, `b` to the next item of `bVec` and `c` to the next item of `cVec`.

:For Statement

```

|
| :For var :In[Each] aexp
|
| code
|
| :End[For]
|

```

Select Statement**:Select aexp**

A **:Select** structure is used to execute alternative blocks of code depending upon the value of an array. For example, the following displays 'I is 1' if the variable **I** has the value 1, 'I is 2' if it is 2, or 'I is neither 1 nor 2' if it has some other value.

```

[1]  :Select I
[2]  :Case 1
[3]    'I is 1'
[4]  :Case 2
[5]    'I is 2'
[6]  :Else
[7]    'I is neither 1 nor 2'
[8]  :EndSelect

```

In this case, the system compares the value of the array expression to the right of the **:Select** statement with each of the expressions to the right of the **:Case** statements and executes the block of code following the one that matches. If none match, it executes the code following the **:Else** (which is optional). Note that comparisons are performed using the **≡** primitive function, so the arrays must match exactly. Note also that not all of the **:Case** expressions are necessarily evaluated because the process stops as soon as a matching expression is found.

Instead of a **:Case** statement, you may also use a **:CaseList** statement. If so, the *enclose* of the array expression to the right of **:Select** is tested for membership of the array expression to the right of the **:CaseList** using the **ε** primitive function.

Note also that any code placed between the **:Select** and the first **:Case** or **:CaseList** statements are unreachable; future versions of Dyalog APL may generate an error when attempting to fix functions which include such code.

Example

```

[1]  :Select ?6 6
[2]  :Case 6 6
[3]  'Box Cars'
[4]  :Case 1 1
[5]  'Snake Eyes'
[6]  :CaseList 2p"16
[7]  'Pair'
[8]  :CaseList (16),"φ16
[9]  'Seven'
[10] :Else
[11] 'Unlucky'
[12] :EndSelect

```

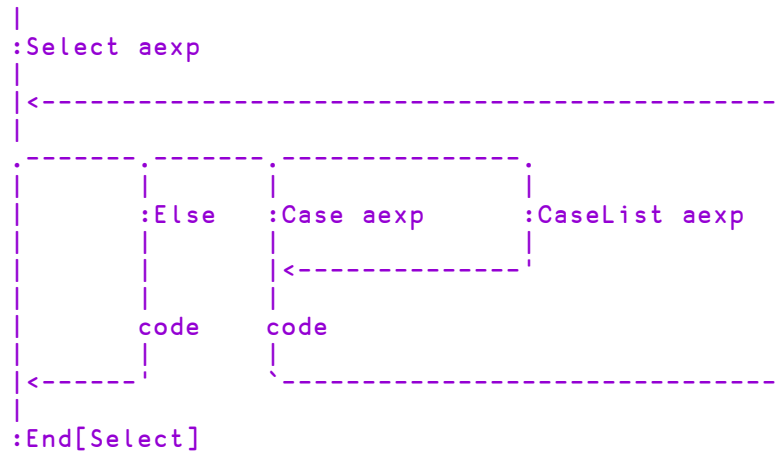
:Select Statement

With Statement

:With obj

`:With` is a control structure that may be used to simplify a series of references to an object or namespace. `:With` changes into the specified namespace for the duration of the control structure, and is terminated by `:End[With]`. `obj` is either the name of or a reference to a namespace. For example, you could update several properties of a Grid object `F.G` as follows:

```
:With F.G
  Values←4 3p0
  RowTitles←'North' 'South' 'East' 'West'
  ColTitles←'Cakes' 'Buns' 'Biscuits'
:EndWith
```

`:With` is analogous to `□CS` in the following senses:

- The namespace argument to `:With` is interpreted relative to the current space.
- With the exception of those with name class 9, local names in the containing defined function continue to be visible in the new space.
- Global references from within the `:With` control structure are to names in the new space.
- Exiting the defined function from within a `:With` control structure causes the space to revert to the one from which the function was called.

On leaving the `:With` control structure, execution reverts to the original namespace. Notice however that the interpreter does not detect branches (`→`) out of the control structure. `:With` control structures can be nested in the normal fashion:

```
[1] :With 'x'           A Change to #.x
[2]   :With 'y'       A Change to #.x.y
[3]     :With □SE     A Change to □SE
[4]       ...         A ... in □SE
[5]         :EndWith  A Back to #.x.y
[6]           :EndWith A Back to #.x
[7]             :EndWith A Back to #
```

:With Statement

```
|
| :With namespace (ref or name)
|
| code
|
| :End[With]
|
```

Hold Statement

:Hold tkns

Whenever more than one thread tries to access the same piece of data or shared resource at the same time, you need some type of synchronisation to control access to that data. This is provided by **:Hold**.

:Hold provides a mechanism to control thread entry into a critical section of code. **tkns** must be a simple character vector or scalar, or a vector of character vectors. **tkns** represents a set of "tokens", all of which must be acquired before the thread can continue into the control structure. **:Hold** is analogous to the component file system **□FHOLD** which is used to synchronise access between **processes**. See also *Language Reference Guide: File Hold*.

Within the whole active workspace, a token with a particular value may be held only once. If the hold succeeds, the current thread *acquires* the tokens and execution continues with the first phrase in the control structure. On exit from the structure, the tokens are released for use by other threads. If the hold fails, because one or more of the tokens is already in use:

1. If there is no **:Else** clause in the control structure, execution of the thread is blocked until the requested tokens become available.
2. Otherwise, acquisition of the tokens is abandoned and execution resumed immediately at the first phrase in the **:Else** clause.

tkns can be either a single token:

```
'a'
'Red'
'#.Util'
,
'Program Files'
```

... or a number of tokens:

```
'red' 'green' 'blue'
'doe' 'a' 'deer'
,
'abc'
↓□nl 9
```

Pre-processing removes trailing blanks from each token before comparison, so that, for example, the following two statements are equivalent:

```
:Hold 'Red' 'Green'
:Hold ↓2 5p'Red Green'
```

Unlike `⊔HOLD`, a thread does not release all existing tokens before attempting to acquire new ones. This enables the nesting of holds, which can be useful when multiple threads are concurrently updating parts of a complex data structure.

In the following example, a thread updates a critical structure in a child namespace, and then updates a structure in its parent space. The holds will allow all "sibling" namespaces to update concurrently, but will constrain updates to the parent structure to be executed one at a time.

```

:Hold ⊔cs''           A Hold child space
  ⋮                  A Update child space
:Hold ##.⊔cs''       A Hold parent space
  ⋮                  A Update Parent space
:EndHold
  ⋮
:EndHold

```

However, with the nesting of holds comes the possibility of a "deadlock". For example, consider the two threads:

Thread 1	Thread 2
<pre> :Hold 'red' ⋮ :Hold 'green' ⋮ :EndHold :EndHold </pre>	<pre> :Hold 'green' ⋮ :Hold 'red' ⋮ :EndHold :EndHold </pre>

In this case if both threads succeed in acquiring their first hold, they will both block waiting for the other to release its token.

If this deadlock situation is detected acquisition of the tokens is abandoned. Then:

1. If there is an `:Else` clause in the control structure, execution jumps to the `:Else` clause.
2. Otherwise, APL issues an error `(1008) DEADLOCK`.

You can avoid deadlock by ensuring that threads always attempt to acquire tokens in the same chronological order, and that threads never attempt to acquire tokens that they already own.

Note that token acquisition for any particular `:Hold` is atomic, that is, either *all* of the tokens or *none* of them are acquired. The following example *cannot* deadlock:

Thread 1	Thread 2
<pre> :Hold 'red' ... :Hold 'green' ... :EndHold :EndHold </pre>	<pre> :Hold 'green' 'red' ... :EndHold </pre>

Examples

`:Hold` could be used for example, during the update of a complex data structure that might take several lines of code. In this case, an appropriate value for the token would be the name of the data structure variable itself, although this is just a programming convention: the interpreter does not associate the token value with the data variable.

```

:Hold 'Struct'
  ...
  Struct ← ...
:EndHold

```

A Update Struct

The next example guarantees exclusive use of the current namespace:

```

:Hold []CS''
  ...
:EndHold

```

A Hold current space

The following example shows code that holds two positions in a vector while the contents are exchanged.

```

:Hold #`to fm
  :If >/vec[fm to]
    vec[fm to]←vec[to fm]
  :End
:End

```

Between obtaining the next available file tie number and using it:

```

:Hold []FNUMS'
  tie←1+[/0,[]FNUMS
  fname []FSTIE tie
:End

```

The above hold is not necessary if the code is combined into a single line:

```
fname []FSTIE tie←1+[/0,[]FNUMS
```

or,

```
tie←fname []FSTIE 0
```

Note that `:Hold`, like its component file system counterpart `MFHOLD`, is a device to enable *co-operating* threads to synchronise their operation.

`:Hold` does not *prevent* threads from updating the same data structures concurrently, it prevents threads only from `:Holding` the same tokens.

`:Hold` Statement

```

|
| :Hold token(s)
|
| code
|
|-----|
|                                     | :Else
|                                     |
|                                     | code
|-----|
| <-----|
|
| :End[Hold]
|

```

High-Priority Callbacks

`:Hold` is not permitted in a high-priority callback and an attempt to use it will cause the error:

```
DOMAIN ERROR: Cannot :Hold within high priority callback
```

See *Interface Guide: High-Priority Callbacks*.

Trap Statement

:Trap ecode

:Trap is an error trapping mechanism that can be used in conjunction with, or as an alternative to, the `⌈TRAP` system variable. It is equivalent to APL2's `⌈EA`, except that the code to be executed is not restricted to a single expression and is not contained within quotes (and so is slightly more efficient).

ecode is an integer scalar or vector containing the list of event codes which are to be *handled* during execution of the segment of code between the **:Trap** and **:End [Trap]** statements. Note that event codes 0 and 1000 are wild cards that means *any* event code in a given range. See [APL Error Messages on page 272](#).

Operation

The segment of code immediately following the **:Trap** keyword is executed. On completion of this segment, if no error occurs, control passes to the code following **:End [Trap]**.

If an error occurs which is not specified by **ecode**, it is processed by outer **:Traps**, `⌈TRAP`s, or by the default system processing in the normal fashion.

If an error occurs, whose event code matches **ecode**:

- If the error occurred within a sub-function, the system cuts the state indicator back to the function containing the **:Trap** keyword. In this respect, **:Trap** behaves like `⌈TRAP` with a 'C' qualifier.
- If the **:Trap** segment contains a **:Case [List] ecode** statement whose **ecode** matches the event code of the error that has occurred, execution continues from the statement following that **:Case [List] ecode**.
- Otherwise, if the **:Trap** segment contains a **:Else** statement, execution continues from the first statement following the **:Else** statement.
- Otherwise, execution continues from the first statement following the **:End [Trap]** and no error processing occurs.

Note that the error trapping is in effect **only** during execution of the initial code segment. When a trapped error occurs, further error trapping is immediately disabled (or surrendered to outer level **:Traps** or `⌈TRAP`s). In particular, the error trap is no longer in effect during processing of **:Case [List]**'s argument or in the code following the **:Case [List]** or **:Else** statement. This avoids the situation sometimes encountered with `⌈TRAP` where an infinite "trap loop" occurs.

Note that the statement **:Trap 0** results in no errors being trapped.

Examples

```

▽ lx
[1]   :Trap 1000           A Cutback and exit on interrupt
[2]   Main ...
[3]   :EndTrap
▽

▽ ftie←Fcreate file      A Create null component file
[1]   :Trap 22           A Trap FILE NAME ERROR
[2]   ftie←file □FCREATE 0 A Try to create file.
[3]   :Else
[4]   ftie←file □FTIE 0   A Tie the file.
[5]   file □FERASE ftie   A Drop the file.
[6]   file □FCREATE ftie  A Create new file.
[7]   :EndTrap
▽

▽ lx A Distinguish various cases
[1]   :Trap 0 1000
[2]   Main ...
[3]   :Case 1002
[4]   'Interrupted ...'
[5]   :CaseList 1 10 72 76
[6]   'Not enough resources'
[7]   :CaseList 17+i20
[8]   'File System Problem'
[9]   :Else
[10]  'Unexpected Error'
[11]  :EndTrap
▽

```

Note that `:Traps` can be nested:

```

▽ ntie←Ntie file        A Tie native file
[1]   :Trap 22          A Trap FILE NAME ERROR
[2]   ntie←file □NTIE 0 A Try to tie file
[3]   :Else
[4]   :Trap 22          A Trap FILE NAME ERROR
[5]   ntie←(file, '.txt')□NTIE 0 A Try with .txt extn
[6]   :Else
[7]   ntie←file □NCREATE 0 A Create null file.
[8]   :EndTrap
[9]   :EndTrap
▽

```

:Trap Statement

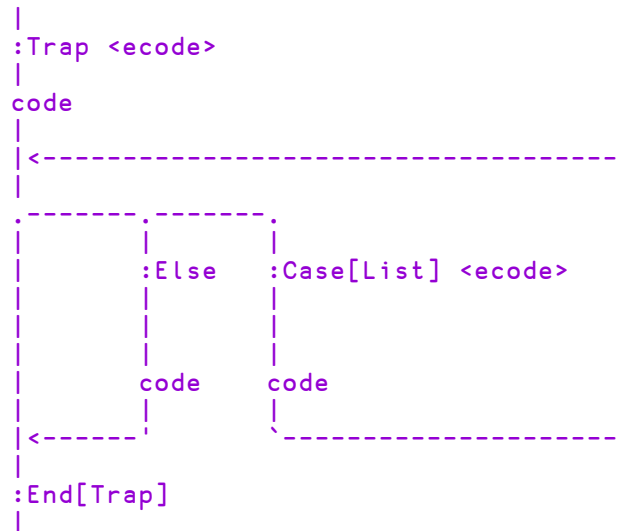

Where `ecode` is a scalar or vector of `TRAP` event codes.

Note that within the `:Trap` control structure, `:Case` is used for a single event code and `:CaseList` for a vector of event codes.

GoTo Statement**:GoTo aexp**

A **:GoTo** statement is a direct alternative to **→** (branch) and causes execution to jump to the line specified by the first element of **aexp**.

The following are equivalent. See *Language Reference Guide: Branch* for further details.

```
→Exit
:GoTo Exit

→(N<I←I+1)/End
:GoTo (N<I←I+1)/End

→1+□LC
:GoTo 1+□LC

→10
:GoTo 10
```

Return Statement**:Return**

A **:Return** statement causes a function to terminate and has exactly the same effect as **→0**.

The **:Return** control word takes no argument.

A **:Return** statement may occur anywhere in a function or operator.

Leave Statement**:Leave**

A **:Leave** statement is used to explicitly terminate the execution of a block of statements within a **:For**, **:Repeat** or **:While** control structure.

The **:Leave** control word takes no argument.

Continue Statement

:Continue

A **:Continue** statement starts the next iteration of the immediately surrounding **:For**, **:Repeat** or **:While** control loop.

When executed within a **:For** loop, the effect is to start the body of the loop with the next value of the iteration variable.

When executed within a **:Repeat** or **:While** loop, if there is a trailing test that test is executed and, if the result is true, the loop is terminated. Otherwise the leading test is executed in the normal fashion.

Section Statement

:Section

Functions and scripted objects (classes, namespaces etc.) can be subdivided into Sections with **:Section** and **:EndSection** statements. Both statements may be followed by an optional and arbitrary name or description. The purpose is to split the function up into sections that you can open and close in the Editor, thereby aiding readability and code management. Sections have no effect on the execution of the code, but must follow the nesting rules of other control structures.

Disposable Statement

:Disposable

The Dyalog interface to .NET involves the creation and removal of .NET objects. Many such objects are *managed* in that the .NET Common Language RunTime (CLR) automatically releases the memory allocated to the object when that object is no longer used. However, it is not possible to predict when the CLR garbage collection will occur. Furthermore, the garbage collector has no knowledge of *unmanaged* resources such as window handles, or open files and streams.

Typically, .NET classes implement a special interface called `IDisposable` which provides a standard way for applications to release memory and other resources when an instance is removed. Furthermore, the C# language has the `using` keyword, which "Provides a convenient syntax that ensures the correct use of `IDisposable` objects."

The **:Disposable array** statement in Dyalog APL provides a similar facility to C#'s `using`. **array** may be a scalar or vector of namespace references.

When the block is exited, any .NET objects in **array** that implement `IDisposable` will have `IDisposable.Dispose` called on them.

Note that exit includes normal exit as the code drops through `:EndDisposable`, or if an error occurs and is trapped, or if branch (`→`) is used to exit the block, or anything else.

See also: *.NET Interface Guide: .Disposing of .NET Objects*.

Example (Normal Exit)

```
:Disposable f←NEW Font
.
.
:EndDisposable
```

In the above example, when the `:EndDisposable` statement is reached, the system disposes of the `Font` object `f` (and all the resources associated with it) by calling `(IDisposable)f.Dispose()`. A subsequent reference to `f` would generate `VALUE ERROR`.

Example (Normal Exit)

```
:Disposable fonts←NEW ``Font Font
.
.
:EndDisposable
```

In the above example, `Dispose()` is called on **each** of the `Font` objects in `fonts` during the processing of `:EndDisposable`.

Example (Branch Exit)

```
:Disposable fonts←NEW ``Font Font
.
→0
.
:EndDisposable
```

In this example, `Dispose()` is called on the `Font` objects in `fonts` during the processing of the branch statement `→0`.

Example (TrapExit)

```
:trap 0
  :Disposable fonts←[]NEW ``Font Font
  .
  ÷0
  .
  :EndDisposable

:else
  []←'failed'

:endif
```

Here, the objects are disposed of when the **DOMAIN ERROR** generated by the expression `÷0` causes the stack to be cut back to the `:Else` clause. At this point (just before the execution of the `:Else` clause) the name class of `fonts` becomes 0.

:Disposable Statement

```
|
| :Disposable array
|
| code
|
| :End[Disposable]
|
```

Triggers

Triggers provide the ability to have a function called automatically whenever a variable or a Field is assigned. Triggers are actioned by all forms of assignment (\leftarrow), but only by assignment.

Triggers are designed to allow a class to perform some action when a field is modified – without having to turn the field into a property and use the property setter function to achieve this. Avoiding the use of a property allows the full use of the APL language to manipulate data in a field, without having to copy field data in and out of the class through get and set functions.

Triggers *can* also be applied to variables outside a class, and there will be situations where this is very useful. However, dynamically attaching and detaching a trigger from a variable is a little tricky at present.

The function that is called when a variable or Field changes is referred to as the *Trigger Function*. The name of a variable or Field which has an associated Trigger Function is termed a *Trigger*.

A function is declared as a Trigger function by including the statement:

```
:Implements Trigger Name1,Name2,Name3, ...
```

where *Name1*, *Name2* etc. are the Triggers.

When a Trigger function is invoked, it is passed an Instance of the internal Class *TriggerArguments*. This Class has 3 Fields:

Member	Description
<i>Name</i>	Name of the Trigger whose change in value has caused the Trigger Function to be invoked.
<i>NewValue</i>	The newly assigned value of the Trigger
<i>OldValue</i>	The previous value of the Trigger. If the Trigger was not previously defined, a reference to this Field causes a VALUE ERROR .

A Trigger Function is called *as soon as possible* after the value of a Trigger was assigned; typically by the end of the currently executing line of APL code. The precise timing is not guaranteed and may not be consistent because internal workspace management operations can occur at any time.

If the value of a Trigger is changed more than once by a line of code, the Trigger Function will be called at least once, but the number of times is not guaranteed.

A Trigger Function is not called when the Trigger is expunged.

Expunging a Trigger disconnects the name from the Trigger Function and the Trigger Function will not be invoked when the Trigger is reassigned. The connection may be re-established by re-fixing the Trigger Function.

A Trigger may have only a single Trigger Function. If the Trigger is named in more than one Trigger Function, the Trigger Function that was last fixed will apply.

In general, it is inadvisable for a Trigger function to modify its own Trigger, as this will potentially cause the Trigger to be invoked repeatedly and forever.

To associate a Trigger function with a *local* name, it is necessary to dynamically fix the Trigger function in the function in which the Trigger is localised; for example:

```

    ▽ TRIG arg
[1]   :Implements Trigger A
[2]   ...

    ▽ TEST;A
[1]   □FX □OR 'TRIG'
[2]   A←10

```

Example

The following function displays information when the value of variables **A** or **B** changes.

```

    ▽ TRIG arg
[1]   :Implements Trigger A,B
[2]   arg.Name'is now 'arg.NewValue
[3]   :Trap 6 A VALUE ERROR
[4]   arg.Name'was      'arg.OldValue
[5]   :Else
[6]   arg.Name' was      [undefined]'
[7]   :EndTrap
    ▽

```

Note that on the very first assignment to **A**, when the variable was previously undefined, **arg.OldValue** is a **VALUE ERROR**.

```

      A←10
A is now 10
A was [undefined]

      A←+10
A is now 20
A was 10

      A←'Hello World'
A is now Hello World
A was 20

      A[1]←c2 3p16
A is now 1 2 3 ello World
      4 5 6
A was Hello World

      B←φ**A
B is now 3 2 1 ello World
      6 5 4
B was [undefined]

      A←[]NEW MyClass
A is now #.[Instance of MyClass]
A was 1 2 3 ello World
      4 5 6

      'F'←[]WC'Form'
      A←F
A is now #.F
A was #.[Instance of MyClass]

```

Note that Trigger functions are actioned only by assignment, so changing **A** to a Form using `[]WC` does not invoke **TRIG**.

```

'A'←[]WC'FORM' A Note that Trigger Function is not
invoked

```

However, the connection (between **A** and **TRIG**) remains and the Trigger Function will be invoked if and when the Trigger is re-assigned.

```

      A←99
A is now 99
A was #.A

```

See [Trigger Fields on page 184](#) for information on how a Field (in a Class) may be used as a Trigger.

Global Triggers

A global Trigger is a function that triggers on any assignment to a global variable in the same namespace. Global Triggers may be disabled and re-enabled using [2007i](#). See *Language Reference Guide: Disable Global Triggers*.

This is implemented by the function declaration statement:

```
:Implements Trigger *
```

The argument to the trigger function is an instance of the internal class `TriggerArguments` which contains the following members:

Member	Description
<code>Name</code>	The name of the global variable that is about to be changed.
<code>Indexers</code>	If the assignment is some form of indexed assignment, <code>Indexers</code> is an array with the same shape as the sub-array that was assigned and contains the ravel-order, <code>IO</code> -sensitive, indices of the changed elements. Otherwise, <code>Indexers</code> is undefined.

Example:

```
▽ foo args
[1]   :Implements Trigger *
[2]   args.Name 'has changed'
[3]   :If 2=args.[]NC 'Indexers'
[4]       ρIndexers' (ρargs.Indexers)
[5]       'Indexers' (, args.Indexers)
[6]   :EndIf
▽

      vec←i5
vec   has changed

      a b←10 'Pete'
a     has changed
b     has changed

      vec[2 4]←99
vec   has changed
ρIndexers 2
Indexers 2 4
```



```

    array←2 3 4p12
array has changed

    (2 1 3↑array)←42
array has changed
pIndexers 2 1 3
Indexers 1 2 3 13 14 15

```

Notes

- like other Triggers, only the most recently fixed global trigger function will apply and be called on assignment to a global variable.
- global triggers do not apply to local names nor to semi-globals (names which are localised further up the stack).
- an assignment to a global variable will fire both its specific trigger (if defined) and the global trigger. However, the order of execution is undefined.
- do not use an argument name for your trigger function that may conflict with a global variable name in the namespace.

Further Example

A potential use for a global trigger is to detect the unintended creation of global variables due to localisation omissions. Note however that the timing of the activation of the Trigger is unpredictable. In this example, the trigger for the assignment to `b` activates after function `hoo` has exited. When Threads are involved, timing becomes even less predictable.

```

    ▽ CatchGlobals arg
[1]   A Displays a warning when a global is assigned
[2]   :Implements Trigger *
[3]   '*** assignment to global variable: ',
      arg.Name,' from ',1↓SI
    ▽
    ▽ foo
[1]   goo
    ▽
    ▽ goo
[1]   hoo
    ▽
    ▽ hoo
[1]   a←10
[2]   b←a
    ▽
    foo
*** assignment to global variable: a from hoo goo foo
*** assignment to global variable: b from goo foo

```

Idiom Recognition

Idioms are commonly used expressions that are recognised and evaluated internally, providing a significant performance improvement.

For example, the idiom $BV/\iota\rho A$ (where BV is a Boolean vector and A is an array) would (in earlier Versions of Dyalog APL) have been evaluated in 3 steps as follows:

1. Evaluate ρA and store result in temporary variable $temp1$ ($temp1$ is just an arbitrary name for the purposes of this explanation)
2. Evaluate $\iota temp1$ and store result in temporary variable $temp2$.
3. Evaluate $BV/temp2$
4. Discard temporary variables

In the current Version of Dyalog APL, the expression is recognised in its entirety and processed in a single step as if it were a single primitive function. In this case, the resultant improvement in performance is between 2 and 4.5.

Idiom recognition is precise; an expression that is almost identical but not exactly identical to an expression given in the [Idiom List on page 122](#) table will not be recognised.

For example, $\square AV \iota$ will be recognised as an idiom, but $(\square AV) \iota$ will not. Similarly, $(,)/$ would not be recognized as the Join idiom.

Idiom List

In the following table, arguments to the idiom have types and ranks as follows:

Type	Description	Rank	Description
C	Character	S	Scalar or 1-item vector
B	Boolean	V	Vector
N	Numeric	M	Matrix
P	Nested	A	Array of any rank
X	any type		

For example: NV: numeric vector, CM: character matrix, PV: nested vector.

Idiom	Description
$\rho\rho XA$	The rank of XA as a 1-element vector
$\neq\rho XA$	The rank of XA as a scalar
$BV/\iota NS$	The subset of NS corresponding to the 1s in BV
$BV/\iota\rho XV$	The positions in XV corresponding to the 1s in BV
$NA=>''cXV$	The subset of XV in the index positions defined by NA (equivalent to $XV[NA]$)
$XA1\{\}XA2$	$XA1$ and $XA2$ are ignored (no result produced)
$XA1\{\alpha\}XA2$	$XA1$ ($XA2$ is ignored)
$XA1\{\omega\}XA2$	$XA2$ ($XA1$ is ignored)
$XA1\{\alpha \ \omega\}XA2$	$XA1$ and $XA2$ as a two item vector ($XA1$ $XA2$)
$\{0\}XA$	0 irrespective of XA
$\{0\}''XA$	0 corresponding to each item of XA
$,/PV$	The enclose of the items of PV (which must be of depth 2) catenated along their last axes
$\bar{/}PV$	The enclose of the items of PV (which must be of depth 2) catenated along their first axes
$\Rightarrow\phi XA$	The item in the top right of XA ($\square ML < 2$)
$\uparrow\phi XA$	The item in the top right of XA ($\square ML \geq 2$)
$\Rightarrow\phi, XA$	The item in the bottom right of XA ($\square ML < 2$)
$\uparrow\phi, A$	The item in the bottom right of XA ($\square ML \geq 2$)
$0=\rho XV$	1 if XV has a shape of zero, 0 otherwise

Expression	Description
$0 = \rho \rho XA$	1 if XA has a rank of zero (scalar), 0 otherwise
$0 = \equiv XA$	1 if XA has a depth of zero (simple scalar), 0 otherwise
$XM1 \{ (\downarrow \alpha) \downarrow \omega \} XM2$	A simple vector comprising as many items as there are rows in $XM2$, where each item is the number of the first row in $XM1$ that matches each row in $XM2$.
$\downarrow \Phi \uparrow PV$	A nested vector comprising vectors that each correspond to a position in the original vectors of PV – the first vector contains the first item from each vector in PV , padded to be the same length as the largest vector, and so on ($\square ML < 2$)
$\downarrow \Phi \geq PV$	A nested vector comprising vectors that each correspond to a position in the original vectors of PV – the first vector contains the first item from each vector in PV , padded to be the same length as the largest vector, and so on ($\square ML \geq 2$)
$\wedge \backslash ' ' = CA$	A Boolean mask indicating the leading blank spaces in each row of CA
$+ / \wedge \backslash ' ' = CA$	The number of leading blank spaces in each row of CA
$+ / \wedge \backslash BA$	The number of leading 1s in each row of BA
$\{ (\vee \backslash ' ' \neq \omega) / \omega \} CV$	CV without any leading blank spaces
$\{ (+ / \wedge \backslash ' ' = \omega) \downarrow \omega \} CV$	CV without any leading blank spaces
$\sim \circ ' ' \uparrow \downarrow CA$	A nested vector comprising simple character vectors constructed from the rows of CA (which must be of depth 1) with all blank spaces removed
$\{ (+ / \vee \backslash ' ' \neq \phi \omega) \uparrow \downarrow \omega \} CA$	A nested vector comprising simple character vectors constructed from the rows of CA (which must be of depth 1) with trailing blank spaces removed

Expression	Description
$\rightarrow \circ \rho \cdot \cdot XA$	The length of the first axis of each item in XA ($\square ML < 2$)
$\uparrow \circ \rho \cdot \cdot XA$	The length of the first axis of each item in XA ($\square ML \geq 2$)
$XA1, \leftarrow XA2$	$XA1$ redefined to be $XA1$ with $XA2$ catenated along its last axis
$XA1 \rightarrow \leftarrow XA2$	$XA1$ redefined to be $XA1$ with $XA2$ catenated along its first axis
$\{(\leftarrow \Delta \omega) \square \omega\} XA$	XA sorted into ascending order
$\{(\leftarrow \Psi \omega) \square \omega\} XA$	XA sorted into descending order
$\{\omega [\leftarrow \Delta \omega]\} XV$	XV sorted into ascending order
$\{\omega [\leftarrow \Psi \omega]\} XV$	XV sorted into descending order
$\{\omega [\leftarrow \Delta \omega;]\} XM$	XM with the rows sorted into ascending order
$\{\omega [\leftarrow \Psi \omega;]\} XM$	XM with the rows sorted into descending order
$1 \equiv XA$	1 if XA has a depth of 1 (simple array), 0 otherwise
$1 \equiv , XA$	1 if XA has a depth of 0 or 1 (simple scalar, vector, etc.), 0 otherwise
$0 \in \rho XA$	1 if XA is empty, 0 otherwise
$\sim 0 \in \rho XA$	1 if XA is not empty, 0 otherwise
$\rightarrow \neq XA$	The first sub-array along the first axis of XA
\rightarrow / XA	The first sub-array along the last axis of XA
$\leftarrow \neq XA$	The last sub-array along the first axis of XA
\leftarrow / XA	The last sub-array along the last axis of XA
$\ast \circ NA$	Euler's idiom (accurate when NA is a multiple of $0J0.5$)

Expression	Description
$0 \Rightarrow \rho XA$	1 if XA has an empty first dimension, 0 otherwise ($\square ML < 2$)
$0 \neq \rho XA$	1 if XA does not have an empty first dimension, 0 otherwise ($\square ML < 2$)
$\square AV \iota CA$	Classic version only: The character numbers (atomic vector index) corresponding to the characters in CA
$\lfloor 0.5 + NA$	Round to nearest integer
$XA \downarrow \ddot{+} NS$	This idiom applies only when NS is negative, when it removes the last $-NS$ items from XA along its leading axis. See note below.
$\{ (= \Phi \omega) \square \omega \}$ $\{ (= \Psi \omega) \square \omega \}$	These idioms provide the fastest way to sort arrays of any rank

Notes

$/\iota$ and $/\iota\rho$, as well as providing an execution time advantage, reduce intermediate workspace usage and, consequently, the incidence of memory compactions and the likelihood of a **WS FULL**.

$NA \supset \text{``} = XV$ is implemented as $XV[NA]$, which is significantly faster. The two are equivalent but the former now has no performance penalty.

$,/$ is special-cased only for vectors of vectors or scalars. Otherwise, the expression is evaluated as a series of concatenations. Recognition of this idiom turns **join** from an *n-squared* algorithm into a linear one. In other words, the improvement factor is proportional to the size of the argument vector.

$=\phi$ and $\Rightarrow\phi$, now take constant time. Without idiom recognition, the time taken depends linearly on the number of items in the argument.

$0 \equiv$ takes a small constant time. Without idiom recognition, the time taken would depend on the size and depth of the argument, which in the case of a deeply nested array could be significant.

$\downarrow\Phi\uparrow$ is special-cased only for a vector of nested vectors, each of whose items is of the same length.

`{(↓α)ι↓ω}` can accommodate much larger matrices than its constituent primitives. It is particularly effective when bound with a left argument using the compose operator:

```
find←mat◦{(↓α)ι↓ω}      A find rows in mat table
```

In this case, the internal hash table for `mat` is retained so that it does not need to be generated each time the monadic derived function `find` is applied to a matrix argument.

`{(∨\ ' ≠ω)/ω}` and `{(+/\^ \ ' =ω)↓ω}` are two codings of the same idiom. Both use the same C code for evaluation.

`~◦ ' ' ' ↓` typically takes a character matrix argument and returns a vector of character vectors from which all blanks have been removed. An example might be the character matrix of names returned by the system function `□NL`. In general, this idiom accommodates character arrays of any rank.

`{(+/∨\ ' ≠φω)↑ ' ↓ω}` typically takes a character matrix argument and returns a vector of character vectors. Any embedded blanks in each row are preserved but trailing blanks are removed. In general, this idiom accommodates character arrays of any rank.

`◦◦ρ ' A (□ML<2)` and `↑◦ρ ' A (□ML>2)` avoid having to create an intermediate nested array of shape vectors.

For an array of vectors, this idiom quickly returns a *simple array* of the length of each vector.

```
◦◦ρ ' 'Hi' 'Pete' A Vector Lengths
2 4
```

For an array of matrices, it returns a simple array of the number of rows in each matrix.

```
◦◦ρ '□CR ' ↓□NL 3 A Lines in functions
5 21...
```

`A, ←A` and `A; ←A` optimise the catenation of an array to another array along the last and first dimension respectively.

Among other examples, this idiom optimises repeated catenation of a scalar or vector to an existing vector.

```
props, ←c 'Posn' 0 0
props, ←c 'Size' 50 50
vector, ←2+4
```

Note that the idiom is not applied if the value of vector `V` is shared with another symbol in the workspace, as illustrated in the following examples:

Example 1: the idiom is used to perform the catenation to **V1**.

```
V1←ι10
V1,←11
```

Example 2: the idiom is not used to perform the catenation to **V1**, because its value is at that point shared with **V2**.

```
V1←ι10
V2←V1
V1,←11
```

Example 3: the idiom is not used to perform the catenation to **V** in **Join[1]** because its value is, at that point, shared with the array used to call the function.

```
▽ V←V Join A
[1] V,←A
▽
(ι10) Join 11
1 2 3 4 5 6 7 8 9 10 11
```

\leftarrow / \rightarrow **XA**, \leftarrow / \rightarrow **XA**, \leftarrow / \rightarrow **XA**, and \leftarrow / \rightarrow **XA** return the first/last rank ($0 \uparrow^{-1} + \rho \rho A$) sub-array along the first/last axis of **XA**. For example, if **V** is a vector, then:

\leftarrow / V	First item of vector
\rightarrow / V	Last item of vector

Similarly, if **M** is a matrix, then:

\leftarrow / M	First row of matrix
\leftarrow / M	First column of matrix
\rightarrow / M	Last row of matrix
\rightarrow / M	Last column of matrix

The idiom generalises uniformly to higher-rank arrays.

Euler's idiom $\ast \circ \mathbf{NA}$ produces accurate results for right argument values that are a multiple of $0\mathbf{J}0.5$. This is so that Euler's famous identity $0=1+\ast \circ 0\mathbf{J}1$ holds, despite pi being represented as a floating point number.

For clarification; $\mathbf{XA} \uparrow \rightarrow \mathbf{NS}$. If **NS** is $\rightarrow 3$ then the idiom removes the last $\rightarrow 3$ (i.e. 3) items.

Search Functions and Hash Tables

Primitive dyadic *search* functions, such as ι (index of) and ϵ (membership) have a *principal* argument in which items of the other *subject* argument are located.

In the case of ι , the principal argument is the one on the left and in the case of ϵ , it is the one on the right. The following table shows the principal (P) and subject (s) arguments for each of the functions.

$P \iota s$	Index of
$s \epsilon P$	Membership
$s \cap P$	Intersection
$P \cup s$	Union
$s \sim P$	Without
$P \{(\downarrow\alpha)\iota\downarrow\omega\} s$	Matrix Iota (idiom)
$P \circ \Delta$ and $P \circ \Psi$	Sort

The Dyalog APL implementation of these functions already uses a technique known as *hashing* to improve performance over a simple linear search. (Note that $\underline{\epsilon}$ (find) does not employ the same hashing technique, and is excluded from this discussion.)

Building a *hash table* for the principal argument takes a significant time but is rewarded by a considerably quicker search for each item in the subject.

Unfortunately, the hash table is discarded each time the function completes and must be reconstructed for a subsequent call (even if its principal argument is identical to that in the previous one).

For optimal performance of *repeated* search operations, the hash table may be retained between calls, by binding the function with its principal argument using the primitive \circ (compose) operator. The retained hash table is then used directly whenever this monadic derived function is applied to a subject argument.

Notice that retaining the hash table pays off only on a second or subsequent application of the derived function. This usually occurs in one of two ways: either the derived function is named for later (and repeated) use, as in the first example below or it is applied repeatedly as the operand of a primitive or defined operator, as in the second example.

Example: naming a derived function.

```

words←'red' 'ylo' 'grn' 'brn' 'blu' 'pnk' 'blk'
find←words∘ι           A monadic find
function
find'blk' 'blu' 'grn' 'ylo' A
7 5 3 2
find'grn' 'brn' 'ylo' 'red' A fast find
3 4 2 1

```

Example: repeated application by () each operator.**

```

ε∘A''This' 'And' 'That'
1 0 0 0 1 0 0 1 0 0 0

```

Locked Functions & Operators

A defined operation may be locked by the system function `□LOCK`. A locked operation may not be displayed or edited. The system function `□CR` returns an empty matrix of shape 0 0 and the system functions `□NR` and `□VR` return an empty vector for a locked operation.

Stop, trace and monitor settings may be established by the system functions `□STOP`, `□TRACE` and `□MONITOR` respectively. Existing stop, trace and monitor settings are cancelled when an operation is locked.

A locked operation may not be suspended, nor may a locked operation remain pendent when execution is suspended. The state indicator is cut back as described below.

The State Indicator

The state of execution is dynamically recorded in the state indicator. The state indicator identifies the chain of execution for operators, functions and the evaluated or character input/output system variables (□ and □). At the top of the state indicator is the most recently activated operation.

Execution may be suspended by an interrupt, induced by the user, the system, or by a signal induced by the system function □**SIGNAL** or by a stop control set by the system function □**STOP**. If the interrupt (or event which caused the interrupt) is not defined as a trappable event by the system variable □**TRAP**, the state indicator is cut back to the first of either a defined operation or the evaluated input prompt (□) such that there is no locked defined operation in the state indicator. The topmost operation left in the state indicator is said to be **SUSPENDED**. Other operations in the chain of execution are said to be **PENDENT**.

The state indicator may be examined when execution is suspended by the system commands **)SI** and **)SINL**. The names of the defined operations in the state indicator are given by the system functions □**SI** and □**XSI** while the line numbers at which they are suspended or pendent is given by the system variable □**LC**.

Suspended execution may be resumed by use of the Branch function (see *Language Reference Guide: Branch*). Whilst execution is suspended, it is permitted to enter any APL expression for evaluation, thereby adding to the existing state indicator. Therefore, there may be more than one **LEVEL OF SUSPENSION** in the state indicator. If the state indicator is cut back when execution is suspended, it is cut back no further than the prior level of suspension (if any).

Examples

```

    ▽ F
[1]   ▽ G
      ▽

    ▽ G
[1]   ▽ 'FUNCTION G'+
      ▽

      ⋄ 'F'
SYNTAX ERROR
G[1] 'FUNCTION G'+
    ^

    )SI
#.G[1]*
#.F[1]
⋄

```

```

□LOCK 'G'

      ⚡ 'F'
SYNTAX ERROR
F[1] G
      ^

      )SI
#.F[1]*
⚡
#.G[1]*
#.F[1]
⚡

```

A suspended or pendent operation may be edited by the system editor or redefined using □FX provided that it is visible and unlocked. However, pendent operations retain their original definition until they complete, or are cleared from the state indicator. When a new definition is applied, the state indicator is repaired if necessary to reflect changes to the operations, model syntax, local names, or labels.

Dfns & Dops

Introduction

A *dfn* (*dop*)¹ is an alternative function definition style suitable for defining small to medium sized functions. It bridges the gap between operator expressions:

`rank←p∘p` and full "header style" definitions such as:

```
▽ rslt←larg func rarg;local...
```

In its simplest form, a *dfn* is an APL expression enclosed in curly braces `{}`, possibly including the special characters α and ω to represent the left and right arguments of the function respectively. For example:

```
{(+/ω)÷ρω} 1 2 3 4      A Arithmetic Mean (Average)
2.5
3 {ω*÷α} 64            A αth root
4
```

dfns can be named in the normal fashion:

```
mean←{(+/ω)÷ρω}
mean (2 3)(4 5)
2.5 4.5
```

dfns can be defined and used in any context where an APL function may be found, in particular:

- In immediate execution mode as in the examples above.
- Within a defined function or operator.
- As the operand of an operator such as each (`⋄`).
- Within another *dfn*.
- The last point means that it is easy to define nested local functions.

¹The terms *dfn* and *dop* refer to a special type of function (or operator) unique to Dyalog. They were originally named dynamic functions and dynamic operators, later abbreviated to *Dfns* and *Dops* or *D-Fns* and *D-Ops*, but all these terms have been dropped in favour of the current ones.

Multi-Line Dfns

The single expression which provides the result of the dfn may be preceded by any number of assignment statements. Each such statement introduces a name which is local to the function.

For example in the following, the expressions `sum←` and `num←` create **local** definitions `sum` and `num`.

```
mean←{           A Arithmetic mean
  sum←+/ω       A Sum of items
  num←ρω        A Number of items
  sum÷num       A Mean
}
```

An assignment to `ω` is not allowed and will result in an error. For assignment to `α`, see [Default Left Argument on page 135](#).

Note that dfns may be commented in the usual way using `A`.

When the interpreter encounters a local definition, a new local name is created. The name is shadowed dynamically exactly as if the assignment had been preceded by: `□shadow name ◊`.

It is **important** to note the distinction between the two types of statement above. There can be **many** assignment statements, each introducing a new local definition, but only a **single** expression where the result is not assigned. As soon as the interpreter encounters such an expression, it is evaluated and the result returned immediately as the result of the function.

For example, in the following,

```
mean←{           A Arithmetic mean
  sum←+/ω       A Sum of items
  num←ρω        A Number of items
  sum,num       A Attempt to show sum,num (wrong)!
  sum÷num       A ... and return result.
}
```

... as soon as the interpreter encounters the expression `sum,num`, the function terminates with the two item result (`sum,num`) and the following line is not evaluated.

To display arrays to the session from within a dfn, you can use the explicit display forms `⌈←` or `⌋←` as in:

```
mean←{
  sum←+/ω      A Arithmetic mean
  num←ρω      A Sum of items
  ⌈←sum,num    A Number of items
  sum÷num      A show sum,num.
  ... and return result.
}
```

Note that local definitions can be used to specify local nested dfns:

```
rms←{
  root←{ω*0.5}      A Root Mean Square
  mean←{(+/ω)÷ρω}  A ∇ Square root
  square←{ω×ω}     A ∇ Mean
  root mean square
}
```

Default Left Argument

The special syntax: `α←expr` is used to give a default value to the left argument if a dfn is called monadically. For example:

```
root←{
  α←2      A αth root
  ω*÷α    A default to sqrt
}
```

The expression to the right of `α←` is evaluated *only* if its dfn is called with no left argument.

Note that the assignment `α←+` allows an ambivalent function to call an ambivalent sub-function. For example in:

```
foo←{
  α←+
  α goo ω
}
```

If `foo` is given a left argument, this is passed to `goo`. Otherwise, `α` is assigned `+` and the last line is `+ goo ω`, which is a monadic call on `goo` followed by the `+` (Right) of the result of `goo`, which is the same value.

Guards

A Guard is a Boolean-single valued expression followed on the right by a ':'. For example:

```
0≡ω:           A Right arg simple scalar
α<0:           A Left arg negative
```

The guard is followed by a single APL expression: the result of the function.

```
ω≥0: ω*0.5     A Square root if non-negative.
```

A dfn may contain any number of guarded expressions each on a separate line (or collected on the same line separated by diamonds). Guards are evaluated in turn until one of them yields a 1. The corresponding expression to the right of the guard is then evaluated as the result of the function.

If an expression occurs without a guard, it is evaluated immediately as the default result of the function. For example:

```
sign←{
  ω>0: '+ve'      A Positive
  ω=0: 'zero'     A zero
        '-ve'     A Negative (Default)
}
```

Local definitions and guards can be interleaved in any order.

Note again that any code following the first unguarded expression (which terminates the function) could never be executed and would therefore be redundant.

See also [Error-Guards on page 138](#).

Shy Result

Dfns are usually 'pure' functions that take arguments and return explicit results. Occasionally, however, the main purpose of the function might be a side-effect such as the display of information in the session, or the updating of a file, and the value of a result, a secondary consideration. In such circumstances, you might want to make the result 'shy', so that it is discarded unless the calling context requires it. This can be achieved by assigning a dummy variable after a (true) guard:

```
log←{
  tie←α ⍵fstie 0      A Append ω to file α.
  cno←ω ⍵fappend tie A tie number for file,
  tie←⍵funtie tie    A new component number,
  1:rslt←cno          A untie file,
                      A comp number, shy result.
}
```

Lexical Name Scope

When an inner (nested) dfn refers to a name, the interpreter searches for it by looking outwards through enclosing dfns, rather than searching back along the state indicator. This regime, which is more appropriate for nested functions, is said to employ **lexical scope** instead of APL's usual **dynamic scope**. This distinction becomes apparent only if a call is made to a function defined at an outer level. For the more usual inward calls, the two systems are indistinguishable.

For example, in the following function, variable `type` is defined both within `which` itself and within the inner function `fn1`. When `fn1` calls outward to `fn2` and `fn2` refers to `type`, it finds the outer one (with value `'lexical'`) rather than the one defined in `fn1`:

```
which←{
    type←'lexical'
    fn1←{
        type←'dynamic'
        fn2 ω
    }
    fn2←{
        type ω
    }
    fn1 ω
}
which'scope'
lexical scope
```

Error-Guards

An **error-guard** is (an expression that evaluates to) a vector of error numbers (see [APL Error Messages on page 272](#)), followed by the digraph: `::`, followed by an expression, the *body* of the guard, to be evaluated as the result of the function. For example:

```
11 5 :: ω×0 ⍎ Trap DOMAIN and LENGTH errors.
```

In common with `:Trap` and `⌈TRAP`, error numbers 0 and 1000 are catch-alls for synchronous errors and interrupts respectively.

When an error is generated, the system searches dynamically through the calling functions for an error-guard that matches the error. If one is found, the execution environment is unwound to its state immediately *prior* to the error-guard's execution and the body of the error-guard is evaluated as the result of the function. This means that, during evaluation of the body, the guard is no longer in effect and so the danger of a hang caused by an infinite "trap loop", is avoided.

Notice that you can provide "cascading" error trapping in the following way:

```
0::try_2nd  
0::try_1st  
expr
```

In this case, if `expr` generates an error, its immediately preceding `0::` catches it and evaluates `try_1st` leaving the remaining error-guard in scope. If `try_1st` fails, the environment is unwound once again and `try_2nd` is evaluated, this time with no error-guards in scope.

See also [Guards on page 136](#).

Examples:

`Open` returns a handle for a component file. If the exclusive tie fails, it attempts a share-tie and if this fails, it creates a new file. Finally, if all else fails, a handle of 0 is returned.

```
open←{
  0::0           A Handle for component file ω.
  22::ω □FCREATE 0 A Fails:: return 0 handle.
  24 25::ω □FSTIE 0 A FILE NAME:: create new one.
                ω □FTIE 0 A FILE TIED:: try share tie.
                A Attempt to open file.
}
```

An error in `div` causes it to be called recursively with *improved* arguments.

```
div←{
  α←1           A Tolerant division:: α÷0 → α.
  5::↑▽/↓↑α ω A default numerator.
  11::α ▽ ω+ω=0 A LENGTH:: stretch to fit.
  α÷ω          A DOMAIN:: increase divisor.
  A attempt division.
}
```

Notice that some arguments may cause `div` to recur twice:

```
→ 6 4 2 div 3 2
→ 6 4 2 div 3 2 0
→ 6 4 2 div 3 2 1
→ 2 2 2
```

The final example shows the unwinding of the local environment before the error-guard's body is evaluated. Local name `trap` is set to describe the domain of its following error-guard. When an error occurs, the environment is unwound to expose `trap`'s statically correct value.

```
add←{
  trap←'domain' ◇ 11::trap
  trap←'length' ◇ 5::trap
  α+ω
}

5 2 add 3           A Addition succeeds

domain 2 add 'three' A DOMAIN ERROR generated.

length 2 3 add 4 5 6 A LENGTH ERROR generated.
```

Note:

Following the setting of an error-guard, subsequent function calls will disable tail call optimisation:

```

{
  22::'Oops!'      A this error-guard means that ...
  tie←ω []ftie 0
  subfn tie        A ... tail call not optimised
}

```

One way to maintain the tail call optimisation in the presence of an error-guard is to isolate it within an inner function:

```

{
  tie←{
    22::0          A error-guard local to inner fn
    ω []ftie 0
  }ω
  tie=0:'Oops!'
  subfn tie        A ... so this is a tail call
}

```

Dops

The operator equivalent of a dfn is distinguished by the presence of either of the compound symbols $\alpha\alpha$ or $\omega\omega$ anywhere in its definition.

The syntax of a dop is:

- monadic – $\alpha (\alpha\alpha \text{ op}) \omega$
- dyadic – $\alpha (\alpha\alpha \text{ op } \omega\omega) \omega$

where $\alpha\alpha$ and $\omega\omega$ are the left and right operands (functions or arrays) respectively, and α and ω are the arguments of the derived function.

Example

The following monadic `each` operator applies its function operand only to unique elements of its argument. It then distributes the result to match the original argument. This can deliver a performance improvement over the primitive `each (")` operator if the operand function is costly and the argument contains a significant number of duplicate elements. Note however, that if the operand function causes side effects, the operation of dop and primitive versions will be different.

```

each←{
    shp←pω           A Fast each:
                    A Shape and ...
    vec←,ω           A ... ravel of arg.
    nub←uvec         A Vector of unique elements.
    res←αα`nub       A Result for unique elts.
    idx←nub!vec      A Indices of arg in nub ...
    shppidx>`res    A ... distribute result.
}

```

The dyadic `else` operator applies its left (else right) operand to its right argument depending on its left argument.

```

else←{
    α: αα ω         A True: apply Left operand
    ωω ω           A Else, .. Right ..
}
0 1 [else|` 2.5    A Try both false and true.
2 3

```

Recursion

A recursive dfn can refer to itself using its name explicitly, but because we allow unnamed functions, we also need a special symbol for implicit self-reference: '▽'. For example:

```
fact←{           A Factorial ω.
  ω≤1: 1       A Small ω, finished,
  ω×▽ ω-1     A Otherwise recur.
}
```

Implicit self-reference using '▽' has the further advantage that it incurs less interpretative overhead and is therefore quicker. Tail calls using '▽' are particularly efficient.

Recursive dops refer to their derived functions, that is the operator bound with its operand(s) using ▽ or the operator itself using the compound symbol: ▽▽. The first form of self reference is by far the more frequently used.

```
pow←{           A Function power.
  α=0:ω       A Apply function operand α times.
  (α-1)▽ αα ω A αα αα αα ... ω
}
```

Example

The following example shows a rather contrived use of the second form of (operator) self reference. The `exp` operator composes its function operand with itself on each recursive call. This gives the effect of an exponential application of the original operand function:

```
exp←{           A Exponential fn application.
  α=0:αα ω     A Apply operand 2*α times.
  (α-1)αα°αα ▽▽ ω A (αα°αα)°( ... ) ... ω
}
succ←{1+ω}     A Successor (increment).
10 succ exp 0
1024
```

Example

```
▽pow←{ A Function power.
[1]   α=0:ω A Apply function operand α times.
[2]   (α-1)▽ αα ω A αα αα αα ... ω
[3]   }
▽
4 * pow 5000
~0.2720968003
```

Example: Pythagorean triples

The following sequence shows an example of combining dfns and dops in an attempt to find Pythagorean triples: (3 4 5)(5 12 13) ...

```

sqrt←{ω*0.5}           A Square root.
sqrt 9 16 25
3 4 5
hyp←{sqrt+>ω*2}       A Hypoteneuse of
triangle.
hyp(3 4)(4 5)(5 12)
5 6.403124237 13
intg←{ω=⌊ω}          A Whole number?
intg 2.5 3 4.5
0 1 0
pyth←{intg hyp ω}     A Pythagorean pair?
pyth(3 4)(4 9)(5 12)
1 0 1
pairs←{,⌊ω ω}         A Pairs of numbers 1..ω.
pairs 3
1 1 1 2 1 3 2 1 2 2 2 3 3 1 3 2 3 3
filter←{(αα ω)/ω}     A Op: ω filtered by αα.
pyth filter pairs 12  A Pythagorean pairs 1..12
3 4 4 3 5 12 6 8 8 6 9 12 12 5 12 9

```

So far, so good, but we have some duplicates: (6 8) is just double (3 4).

```

rpm←{                  A Relatively prime?
  ω=0:α=1              A C.f. Euclid's gcd.
  ω ∇ ω|α
}/**                  A Note the /**
rpm(2 4)(3 4)(6 8)(16 27)
0 1 0 1
rpm filter pyth filter pairs 20
3 4 4 3 5 12 8 15 12 5 15 8

```

We can use an operator to combine the tests:

```

    and←{
        mask←αα ω
    selects...
        mask\ωω mask/ω
    predicate.
    }

```

```

    pyth and rpm filter pairs 20
3 4 4 3 5 12 8 15 12 5 15 8

```

Better, but we still have some duplicates: (3 4) (4 3)

```

    less←{</>ω}
    less(3 4)(4 3)
1 0

```

```

    less and pyth and rpm filter pairs 40
3 4 5 12 7 24 8 15 9 40 12 35 20 21

```

And finally, as promised, triples:

```

    {ω,hyp ω}“less and pyth and rpm filter pairs 35
3 4 5 5 12 13 7 24 25 8 15 17 12 35 37 20 21 29

```

A Larger Example

Function `tokens` uses nested local dfns to split an APL expression into its constituent tokens. Note that all calls on the inner functions: `lex`, `acc`, and the unnamed dfn in each token case, are *tail calls*. In fact, the *only* stack calls are those on function: `all`, and the unnamed function: `{ωv-1ϕω}`, within the "Char literal" case.

```

tokens←{
  alph←⊂A,⊂Á,'_ΔΔ',26†17†⊂AV      A Lex of APL src line.
  all←{+/^∖α∈ω}                  A Alphabet for names.
  acc←{(α,†/ω)lex>†/ω}           A No. of leading α∈ω.
  lex←{                            A Accumulate tokens.
    0=ρω:α ⋄ hd←†ω                A Next char else done.

    hd=' ':α{                      A White Space.
      size←ω all ' '
      α acc size ω
    }ω

    hdealph:α{                     A Name
      size←ω all alph,⊂D
      α acc size ω
    }ω

    hd∈⊂':':α{                     A System Name/Keyword
      size←ω all hd,alph
      α acc size ω
    }ω

    hd='''':α{                     A Char literal
      size←+/^∖{ωv-1ϕω}≠∖hd=ω
      α acc size ω
    }ω

    hd∈⊂D, '-' :α{                 A Numeric literal
      size←ω all ⊂D, '-E'
      α acc size ω
    }ω

    hd='A':α acc(ρω)ω              A Comment
    α acc 1 ω                      A Single char token.
  }
  (0ρ<'')lex,ω
}
display tokens'xtok←size†srce A Next token'

```



Tail Calls

A novel feature of the implementation of dfns is the way in which tail calls are optimised.

When a dfn calls a sub-function, the result of the call may or may not be modified by the calling function before being returned. A call where the result is passed back immediately without modification is termed a tail call.

For example in the following, the first call on function `fact` is a tail call because the result of `fact` is the result of the whole expression, whereas the second call isn't because the result is subsequently multiplied by ω .

```
( $\alpha \times \omega$ ) fact  $\omega - 1$       A Tail call on fact.
 $\omega \times$  fact  $\omega - 1$       A Embedded call on fact.
```

Tail calls occur frequently in dfns, and the interpreter optimises them by re-using the current stack frame instead of creating a new one. This gives a significant saving in both time and workspace usage. It is easy to check whether a call is a tail call by tracing it. An embedded call will pop up a new trace window for the called function, whereas a tail call will re-use the current one.

Using tail calls can improve code performance considerably, although at first the technique might appear obscure. A simple way to think of a tail call is as a **branch with arguments**. The tail call, in effect, branches to the first line of the function after installing new values for ω and α .

Iterative algorithms can almost always be coded using tail calls.

In general, when coding a loop, we use the following steps; possibly in a different order depending on whether we want to test at the "top" or the "bottom" of the loop.

1. Initialise loop control variable(s). A `init`
2. Test loop control variable. A `test`
3. Process body of loop. A `proc`
4. Modify loop control variable for next iteration. A `mod`
5. Branch to step 2. A `jump`

For example, in classical APL you might find the following:

```
▽ value←limit loop value A init
[1] top:→(⊂CT>value-limit)/0 A test
[2] value←Next value      A proc, mod
[3] →topA jump
▽
```

Control structures help us to package these steps:

```

      ▽ value←limit loop value A init
[1]   :While □CT<value-limit A test
[2]       value←Next value    A proc, mod
[3]   :EndWhile                A jump
      ▽

```

Using tail calls:

```

loop←{A init
      □CT>α-ω:ω    A test
      α ▽ Next ω    A proc, mod, jump
}

```

Restrictions

- **Multi-line** dfns can't be typed directly into the session. The interpreter attempts to evaluate the first line with its trailing left brace and a **SYNTAX ERROR** results.
- Dfns need not return a result. However even a non-result-returning expression will terminate the function, so you can't, for example, call a non-result-returning function from the middle of a dfn.
- You can trace a dfn **only** if it is defined on more than one line. Otherwise it is executed atomically in the same way as an execute (**⚡**) expression. This deliberate restriction is intended to avoid the confusion caused by tracing a line and seeing nothing change on the screen.
- dfns do not currently support **□CS** which, if used, generates a **NONCE ERROR**.
- **□SHADOW** ignores dfns when looking down the stack for a traditional function (tradfn) in which to make a new local name.
- dfns do not support control structures or branch.
- dfns do not support modified assignment such as **X plus←10** where **X** is an array and **plus** is a function. In this example, both **X** and **plus** would be assigned the value 10.
- **□MONITOR** does not apply to dfns and dops.

Supplied Workspaces

You can find many samples of dfns and dops in utility workspace `dfns.dws` in the `ws` sub-directory.

Additional examples are in workspaces: `min.dws`, `max.dws`, `tube.dws` and `eval.dws`.

APL Line Editor

The APL Line Editor described herein is included for completeness and for adherence to the ISO APL standard. Dyalog recommends the use of the more powerful Editor and Tracer in preference to the APL Line Editor. Full details of these facilities can be found in the UI Guides for your version of Dyalog APL, as well as in the descriptions of `⎕ED` and `)ED` which appear in the *Dyalog APL Language Reference Guide*.

Using the APL Line Editor, functions and operators are defined by entering Definition Mode. This mode is opened and closed by the Del symbol, `▽`. Within this mode, all evaluation of input is deferred. The standard APL line editor (described below) is used to create and edit operations within definition mode.

Operations may also be defined using the system function `⎕FX` (implicit in a `⎕ED fix`) which acts upon the canonical (character), vector, nested or object representation form of an operation. (See *Language Reference Guide: Fix Definition* for details.)

Functions may also be created dynamically or by function assignment.

The line editor recognises three forms for the opening request.

Creating Defined Operation

The opening `▽` symbol is followed by the header line of a defined operation. Redundant blanks in the request are permitted except within names. If acceptable, the editor prompts for the first statement of the operation body with the line-number 1 enclosed in brackets. On successful completion of editing, the defined operation becomes the active definition in the workspace.

Example

```
          ▽R←FOO
[1]      R←10
[2]      ▽

          FOO
10
```

The given operation name must not have an active referent in the workspace, otherwise the system reports `defn error` and the system editor is not invoked:

```

)VARS
SALES X Y

∇R←SALES Y
defn error

```

The header line of the operation must be syntactically correct, otherwise the system reports `defn error` and the system editor is not invoked:

```

∇R←A B C D:G
defn error

```

Listing Defined Operation

The `∇` symbol followed by the name of a defined operation and then by a closing `∇`, causes the display of the named operation. Omitting the function name causes the suspended operation (i.e. the one at the top of the state indicator) to be displayed and opened for editing.

Example

```

)FOO∇
∇ R←FOO
[1] R←10
∇

)SI
#.FOO[1] *

∇
∇ R←FOO
[1] R←10
[2]

```

Editing Active Defined Operation

Definition mode is entered by typing `▽` followed optionally by a name and editing directive.

The `▽` symbol on its own causes the suspended operation (i.e. the one at the top of the state indicator) to be displayed. The editor then prompts for a statement or editing directive with a line-number one greater than the highest line-number in the function. If the state indicator is empty, the system reports `defn error` and definition mode is not entered.

The `▽` symbol followed by the name of an active defined operation causes the display of the named operation. The editor then prompts for input as described above. If the name given is not the name of an active referent in the workspace, the opening request is taken to be the creation of a new operation as described in paragraph 1. If the name refers to a pendent operation, the editor issues the message `warning pendent operation` prior to displaying the operation. If the name refers to a locked operation, the system reports `defn error` and definition mode is not entered.

The `▽` symbol followed by the name of an active defined operation and an editing directive causes the operation to be opened for editing and the editing directive actioned. If the editing directive is invalid, it is ignored by the editor which then prompts with a line-number one greater than the highest line-number in the operation. If the name refers to a pendent operation, the editor issues the message `warning pendent operation` prior to actioning the editing directive. If the name refers to a locked operation, the system reports `defn error` and definition mode is not entered.

On successful completion of editing, the defined operation becomes the active definition in the workspace which may replace an existing version of the function. Monitors, and stop and trace vectors are removed.

Example

```
          ▽FOO[2]  
[2]  R+R*2  
[3]  ▽
```

Editing Directives

Editing directives, summarised in Figure 2(iv) are permitted as the first non-blank characters either after the operation name on opening definition mode for an active defined function, or after a line-number prompt.

Syntax	Description
▽	Closes definition mode
[□]	Displays the entire operation
[□n]	Displays the operation starting at line n
[n□]	Displays only line n
[Δn]	Deletes line n
[nΔm]	Deletes m lines starting at line n
[n]	Prompts for input at line n
[n]s	Replaces or inserts a statement at line n
[n□m]	Edits line n placing the cursor at character position m where an Edit Control Symbol performs a specific action.

Line Numbers

Line numbers are associated with lines in the operation. Initially, numbers are assigned as consecutive integers, beginning with [0] for the header line. The number associated with an operation line remains the same for the duration of the definition mode unless altered by editing directives. Additional lines may be inserted by decimal numbering. Up to three places of decimal are permitted. On closing definition mode, operation lines are re-numbered as consecutive integers.

The editor always prompts with a line number. The response may be a statement line or an editing directive. A statement line replaces the existing line (if there is one) or becomes an additional line in the operation:

```

      ∇R←A PLUS B
[1]  R←A+B
[2]

```

Position

The editing directive [n], where n is a line number, causes the editor to prompt for input at that line number. A statement or another editing directive may be entered. If a statement is entered, the next line number to be prompted is the previous number incremented by a unit of the display form of the last decimal digit. Trailing zeros are not displayed in the fractional part of a line number:

```

[2]  [0.8]
[0.8] R MONADIC OR DYADIC +
[0.9] R A ↔ OPTIONAL ARGUMENT
[1]

```

The editing directive [n]s, where n is a line number and s is a statement, causes the statement to replace the current contents of line n, or to insert line n if there is none:

```

[1] [0] R←{A} PLUS B
[1]

```

Delete

The editing directive [Δn], where n is a line number, causes the statement line to be deleted. The form [nΔm], where n is a line number and m is a positive integer, causes m consecutive statement lines starting from line number n to be deleted.

Edit

The editing directive `[n□m]`, where `n` is a line number and `m` is an integer number, causes line number `n` to be displayed and the cursor placed beneath the `m`{th} character on a new line for editing. The response is taken to be edit control symbols selected from:

/	to delete the character immediately above the symbol.
1 to 9	to insert from 1 to 9 spaces immediately prior to the character above the digit.
A to Z	to insert multiples of 5 spaces immediately prior to the character above the letter, where A = 5, B = 10, C = 15 and so forth.
,	to insert the text after the comma, including explicitly entered trailing spaces, prior to the character above the comma, and then re-display the line for further editing with the text inserted and any preceding deletions or space insertions also effected.
.	to insert the text after the comma, including explicitly entered trailing spaces, prior to the character above the comma, and then complete the edit of the line with the text inserted and any preceding deletions or space insertions also effected.

Invalid edit symbols are ignored. If there are no valid edit symbols entered, or if there are only deletion or space insertion symbols, the statement line is re-displayed with characters deleted and spaces inserted as specified. The cursor is placed at the first inserted space position or at the end of the line if none. Characters may be added to the line which is then interpreted as seen.

The line number may be edited.

Examples

```
[1] [1□7]
[1] R←A+B
      ,(O=□NC'A')ρ1←□LC ◇
[1] →(O=□NC'A')ρ1←□LC ◇ R←A+B
                                     .◇→END

[2] R←B
[3] END:
[4]
```

The form `[n□0]` causes the line number `n` to be displayed and the cursor to be positioned at the end of the displayed line, omitting the edit phase.

Display

The editing directive `[□]` causes the entire operation to be displayed. The form `[□n]` causes all lines from line number `n` to be displayed. The form `[n□]` causes only line number `n` to be displayed:

```
[4] [0□]
[0] R←{A} PLUS B
[0]
[0] [□]
[0] R←{A} PLUS B
[0.1] R MONADIC OR DYADIC +
[1] →(O=□NC'A')ρ1+□LC ◇ R←A+B ◇→END
[2] R←B
[3] 'END:
[4]
```

Close Definition Mode

The editing directive `▽` causes definition mode to be closed. The new definition of the operation becomes the active version in the workspace. If the name in the operation header (which may or may not be the name used to enter definition mode) refers to a pendent operation, the editor issues the message **warning pendent operation** before exiting. The new definition becomes the active version, but the original one will continue to be referenced until the operation completes or is cleared from the state indicator.

If the name in the operation header is the name of a visible variable or label, the editor reports `defn error` and remains in definition mode. It is then necessary to edit the header line or quit.

If the header line is changed such that it is syntactically incorrect, the system reports `defn error`, and re-displays the line leaving the cursor beyond the end of the text on the line. Backspace/linefeed editing may be used to alter or cancel the change:

```
[3]  [0] - display line 0
[0]  R←{A} PLUS B
[0]  R←{A} PLUS B;G;H - put syntax error in line 0
defn error
[0]  R←{A} PLUS B;G;H - line redisplayed
      ;G;H - backspace/linefeed editing
[1]
```

Local names may be repeated. However, the line editor reports warning messages as follows:

1. If a name is repeated in the header line, the system reports "warning duplicate name" immediately.
2. If a label has the same name as a name in the header line, the system reports "warning label name present in line 0" on closing definition mode.
3. If a label has the same name as another label, the system reports "warning duplicate label" on closing definition mode.

Improper syntax in expressions within statement lines of the function is not detected by the system editor with the following exceptions:

- If the number of opening parentheses in each entire expression does not equal the number of closing parentheses, the system reports "warning unmatched parentheses", but accepts the line.
- If the number of opening brackets in each entire expression does not equal the number of closing brackets, the system reports "warning unmatched brackets", but accepts the line.

These errors are not detected if they occur in a comment or within quotes. Other syntactical errors in statement lines will remain undetected until the operation is executed.

Example

```
[4] R←(A[;1)=2)≠EXP,'×2
warning unmatched parentheses
warning unmatched brackets
[5]
```

Note that there is an imbalance in the number of quotes. This will result in a **SYNTAX ERROR** when this operation is executed.

Quit Definition Mode

The user may quit definition mode by typing the INTERRUPT character. The active version of the operation (if any) remains unchanged.

Chapter 3:

Object Oriented Programming

Introducing Classes

A Class is a blueprint from which one or more *Instances* of the Class can be created (instances are sometimes also referred to as *Objects*).

A Class may optionally derive from another Class, which is referred to as its Base Class.

A Class may contain *Methods*, *Properties* and *Fields* (commonly referred to together as *Members*) which are defined within the body of the class script or are inherited from other Classes. This version of Dyalog APL does not support *Events* although it is intended that these will be supported in a future release. However, Classes that are derived from .NET types may generate events using `+ [NQ]`.

A Class that is defined to derive from another Class automatically acquires the set of Properties, Methods and Fields that are defined by its Base Class. This mechanism is described as inheritance.

A Class may extend the functionality of its Base Class by adding new Properties, Methods and Fields or by substituting those in the Base Class by providing new versions with the same names as those in the Base Class.

Members may be defined to be Private or Public. A Public member may be used or accessed from outside the Class or an Instance of the Class. A Private member is internal to the Class and (in general) may not be referenced from outside.

Although Classes are generally used as blueprints for the creation of instances, a class can have Shared members which can be used without first creating an instance.

Class Names

Class names must adhere to the general rules for naming APL objects, and in addition should not conflict with the name of a .NET Type that is defined in any of the .NET Namespaces on the search path specified by `[USING]`.

Defining Classes

A Class is defined by a script that may be entered and changed using the editor. A class script may also be constructed from a vector of character vectors, and fixed using `FIX`.

A class script begins with a `:Class` statement and ends with a `:EndClass` statement.

For example, using the editor:

```
        )CLEAR  
clear ws  
        )ED oAnimal
```

[an edit window opens containing the following skeleton Class script ...]

```
:Class Animal  
:EndClass
```

[the user edits and fixes the Class script]

```
        )CLASSES  
Animal  
        [NC='Animal'  
9.4
```

Editing Classes

Between the `:Class` and `:EndClass` statements, you may insert any number of function bodies, Property definitions, and other elements. When you fix the Class Script from the editor, these items will be fixed inside the Class namespace.

Note that the contents of the Class Script defines the Class *in its entirety*. You may not add or alter functions by editing them independently and you may not add variables by assignment or remove objects with `□EX`.

When you *re-fix* a Class Script using the Editor or with `□FIX`, the original Class is discarded and the new definition, as specified by the Script, replaces the old one in its entirety.

Note:

Associated with a Class (or an instance of a class) there is a completely separate namespace which *surrounds* the class and can contain functions, variables and so forth that are created by actions external to the class.

For example, if `X` is *not* a public member of the class `MyClass`, then the following expression will insert a variable `X` into the namespace which surrounds the class:

```
MyClass.X←99
```

The namespace is analogous to the namespace associated with a GUI object and will be re-initialised (emptied) whenever the Class is re-fixed. Objects in this parallel namespace are not visible from inside the Class or an Instance of the Class.

For further information, see [Changing Scripted Objects Dynamically on page 217](#).

Inheritance

If you want a Class to derive from another Class, you simply add the name of that Class to the `:Class` statement using colon+space as a separator.

The following example specifies that `CLASS2` derives from `CLASS1`.

```
:Class CLASS2: CLASS1
:EndClass
```

Note that `CLASS1` is referred to as the *Base Class* of `CLASS2`.

If a Class has a Base Class, it automatically acquires all of the **Public** Properties, Methods and Fields defined for its Base Class unless it replaces them with its own members of the same name. This principle of inheritance applies throughout the Class hierarchy. Note that **Private** members are **not** subject to inheritance.

Warning: When a class is fixed, it keeps a reference (a pointer) to its base class. If the global name of the base class is expunged, the derived class will still have the base class reference, and the base class will therefore be kept *alive* in the workspace. The derived class will be fully functional, but attempts to edit it will fail when it attempts to locate the base class as the new definition is fixed.

At this point, if a new class with the original base class name is created, the derived class has no way of detecting this, and it will continue to use the *old and invisible* version of the base class. Only when the derived class is re-fixed, will the new base class be detected.

If you edit, re-fix or copy an existing base class, APL will take care to patch up the references, but if the base class is expunged first and recreated later, APL is unable to detect the substitution. You can recover from this situation by editing or re-fixing the derived class(es) after the base class has been substituted.

Copying Classes

See *Programming Reference Guide: Copy System Command*.

Classes that derive from .NET Types

You may define a Class that derives from any of the .NET Types by specifying the name of the .NET Type and including a **:USING** statement that provides a path to the .NET Assembly in which the .NET Type is located.

Example

```
:Class APLGreg: GregorianCalendar  
:Using System.Globalization  
...  
:EndClass
```

Classes that derive from the Dyalog GUI

You may define a Class that derives from any of the Dyalog APL GUI objects by specifying the *name* of the Dyalog APL GUI Class in quotes.

For example, to define a Class named **Duck** that derives from a **Poly** object, the Class specification would be:

```
:Class Duck: 'Poly'  
:EndClass
```

The Base Constructor for such a Class is the **□WC** system function.

Instances

A Class is generally used as a blueprint or model from which one or more Instances of the Class are constructed. Note however that a class can have Shared members which can be used directly without first creating an instance.

You create an instance of a Class using the `NEW` system function which is monadic.

The 1-or 2-item argument to `NEW` contains a reference to the Class and, optionally, arguments for its Constructor function.

When `NEW` executes, it creates a regular APL namespace to contain the Instance, and within that it creates an Instance space, which is populated with any Instance Fields defined by the class (with default values if specified), and pointers to the Instance Method and Property definitions specified by the Class.

If a monadic Constructor is defined, it is called with the arguments specified in the second item of the argument to `NEW`. If `NEW` was called without Constructor arguments, and the class has a niladic Constructor, this is called instead.

The Constructor function is typically used to initialise the instance and may establish variables in the instance namespace.

The result of `NEW` is a reference to the instance namespace. Instances of Classes exhibit the same set of Properties, Methods and Fields that are defined for the Class.

Constructors

A Constructor is a special function defined in the Class script that is to be run when an Instance of the Class is created by `NEW`. Typically, the job of a Constructor is to initialise the new Instance in some way.

A Constructor is identified by a `:Implements Constructor` statement. This statement may appear anywhere in the body of the function after the function header. The significance of this is discussed below.

Note that it is also *essential* to define the Constructor to be *Public*, with a `:Access Public` statement, because like all Class members, Constructors default to being *Private*. Private Constructors currently have no use or purpose, but it is intended that they will be supported in a future release of Dyalog APL.

A Constructor function may be niladic or monadic and must not return a result.

A Class may specify any number of different Constructors of which one (and only one) may be niladic. This is also referred to as the *default* Constructor.

There may be any number of monadic Constructors, but each must have a differently defined argument list which specifies the number of items expected in the Constructor argument. See [Constructor Overloading on page 164](#) for details.

The only way a Constructor function should be invoked is by `NEW`. See [Base Constructors on page 171](#) for further details. If you attempt to call a Constructor function from outside its Class, it will cause a `SYNTAX ERROR`. A Constructor function should not call another Constructor function within the same Class, although it will not generate an error. This would cause the Base Constructor to be called twice, with unpredictable consequences.

When `NEW` is executed *with a 2-item argument*, the appropriate monadic Constructor is called with the second item of the `NEW` argument.

The niladic (default) Constructor is called when `NEW` is executed with a 1-item argument, a Class reference alone, or whenever APL needs to create a fill item for the Class.

Note that `NEW` first creates a new instance of the specified Class, and then executes the Constructor inside the instance.

Example

The `DomesticParrot` Class defines a Constructor function `egg` that initialises the Instance by storing its name (supplied as the 2nd item of the argument to `NEW`) in a Public Field called `Name`.

```

:Class DomesticParrot: Parrot
  :Field Public Name

  ▽ egg name
    :Implements Constructor
    :Access Public
    Name←name
  ▽
  ⋮
:EndClass A DomesticParrot

  pol←NEW DomesticParrot 'Polly'
  pol.Name
Polly

```

Constructor Overloading

NameList header syntax is used to define different versions of a Constructor each with a different number of parameters, referred to as its *signature*. See [Namelists on page 83](#) for details. The Clover Class illustrates this principle.

In deciding which Constructor to call, APL matches the shape of the Constructor argument with the signature of each of the Constructors that are defined. If a constructor with the same number of arguments exists (remembering that 0 arguments will match a niladic Constructor), it is called. If there is no exact match, and there is a Constructor with a general signature (an un-parenthesised right argument), it is called. If no suitable constructor is found, a **LENGTH ERROR** is reported.

There may be one and only one constructor with a particular signature.

The only way a Constructor function should be invoked is by **NEW**. See [Base Constructors on page 171](#) for further details. If you attempt to call a Constructor function from outside its Class, it will cause a **SYNTAX ERROR**. A Constructor function should not call another Constructor function within the same Class, although it will not generate an error. This would cause the Base Constructor to be called twice, with unpredictable consequences.

In the Clover Class example Class, the following Constructors are defined:

Constructor	Implied argument
Make1	1-item vector
Make2	2-item vector
Make3	3-item vector
Make0	No argument
MakeAny	Any array accepted

Clover Class Example

```

:Class Clover A Constructor Overload Example
:Field Public Con
  ▽ Make0
    :Access Public
    :Implements Constructor
    make 0
  ▽
  ▽ Make1(arg)
    :Access Public
    :Implements Constructor
    make arg
  ▽
  ▽ Make2(arg1 arg2)
    :Access Public
    :Implements Constructor
    make arg1 arg2
  ▽
  ▽ Make3(arg1 arg2 arg3)
    :Access Public
    :Implements Constructor
    make arg1 arg2 arg3
  ▽
  ▽ MakeAny args
    :Access Public
    :Implements Constructor
    make args
  ▽
  ▽ make args
    Con←(pargs)(2>[]SI)args
  ▽
:EndClass A Clover

```

In the following examples, the `Make` function (see Clover Class for details) displays:

```
<shape of argument> <name of Constructor
called><argument>
(see function make)
```

Creating a new Instance of Clover with a 1-element vector as the Constructor argument, causes the system to choose the `Make1` Constructor. Note that, although the argument to `Make1` is a 1-element vector, this is disclosed as the list of arguments is unpacked into the (single) variable `arg1`.

```
([]NEW Clover(,1)).Con
Make1 1
```

Creating a new Instance of Clover with a 2- or 3-element vector as the Constructor argument causes the system to choose `Make2`, or `Make3` respectively.

```
([]NEW Clover(1 2)).Con
2 Make2 1 2
([]NEW Clover(1 2 3)).Con
3 Make3 1 2 3
```

Creating an Instance with any other Constructor argument causes the system to choose `MakeAny`.

```
([]NEW Clover(ι10)).Con
10 MakeAny 1 2 3 4 5 6 7 8 9 10
([]NEW Clover(2 2ι4)).Con
2 2 MakeAny 1 2
3 4
```

Note that a scalar argument will call `MakeAny` and not `Make1`.

```
([]NEW Clover 1).Con
MakeAny 1
```

and finally, creating an Instance without a Constructor argument causes the system to choose `Make0`.

```
([]NEW Clover).Con
Make0 0
```

Niladic (Default) Constructors

A Class may define a niladic Constructor and/or one or more Monadic Constructors. The niladic Constructor acts as the default Constructor that is used when `NEW` is invoked without arguments and when APL needs a fill item.

```

:Class Bird
  :Field Public Species

  ▽ egg spec
    :Access Public Instance
    :Implements Constructor
    Species←spec
  ▽
  ▽ default
    :Access Public Instance
    :Implements Constructor
    Species←'Default Bird'
  ▽
  ▽ R←Speak
    :Access Public
    R←'Tweet, tweet!'
  ▽

:EndClass A Bird

```

The niladic Constructor (in this example, the function `default`) is invoked when `NEW` is called without Constructor arguments. In this case, the Instance created is no different to one created by the monadic Constructor `egg`, except that the value of the `Species` Field is set to `'Default Bird'`.

```

      Birdy←NEW Bird
      Birdy.Species
Default Bird

```

The niladic Constructor is also used when APL needs to make a fill item of the Class. For example, in the expression `(3↑Birdy)`, APL has to create two fill items of `Birdy` (one for each of the elements required to pad the array to length 3) and will in fact call the niladic Constructor twice.

In the following statement:

```
TweetyPie←3>10↑Birdy
```

The `10↑` (temporarily) creates a 10-element array comprising the single entity `Birdy` padded with 9 fill-elements of Class `Bird`. To obtain the 9 fill-elements, APL calls the niladic Constructor 9 times, one for each separate prototypical Instance that it is required to make.

```
TweetyPie.Species
Default Bird
```

Empty Arrays of Instances: Why ?

In APL it is natural to use *arrays* of Instances. For example, consider the following example.

```
:Class Cheese
  :Field Public Name←''
  :Field Public Strength←0
  ∇ make2(name strength)
    :Access Public
    :Implements Constructor
    Name Strength←name strength
  ∇
  ∇ make1 name
    :Access Public
    :Implements Constructor
    Name Strength←name 1
  ∇
  ∇ make_excuse
    :Access Public
    :Implements Constructor
    ⍵←'The cat ate the last one!'
  ∇
:EndClass
```

We might create an array of Instances of the Cheese Class as follows:

```
cdata←('Camembert' 5)('Caephillly' 2) 'Mild Cheddar'
cheeses←{⍵NEW Cheese ω}''cdata
```

Suppose we want a range of medium-strength cheese for our cheese board.

```
board←(cheeses.Strength<3)/cheeses
board.Name
Caephillly Mild Cheddar
```

But look what happens when we try to select really strong cheese:

```
board←(cheeses.Strength>5)/cheeses
board.Name
The cat ate the last one!
```

Note that this message is not the result of the expression, but was explicitly displayed by the `make_excuse` function. The clue to this behaviour is the shape of `board`; it is empty!

```
0      pboard
```

When a reference is made to an empty array of Instances (strictly speaking, a reference that requires a *prototype*), APL creates a new Instance by calling the *niladic* (default) Constructor, uses the new Instance to satisfy the reference, and then discards it. Hence, in this example, the reference:

```
board.Name
```

caused APL to run the *niladic* Constructor `make_excuse`, which displayed:

```
The cat ate the last one!
```

Notice that the behaviour of empty arrays of Instances is modelled VERY closely after the behaviour of empty arrays in general. In particular, the Class designer is given the task of deciding what the types of the members of the prototype are.

Empty Arrays of Instances: How?

To cater for the need to handle empty arrays of Instances as easily as non-empty arrays, a reference to an empty array of Class Instances is handled in a special way.

Whenever a reference or an assignment is made to the content of an *empty array of Instances*, the following steps are performed:

1. APL creates a *new Instance* of the same Class of which the empty Instance belongs
2. the default (*niladic*) Constructor is run in the new Instance
3. the appropriate value is obtained or assigned:
 - if it is a reference is to a Field, the value of the Field is obtained
 - if it is a reference is to a Property, the PropertyGet function is run
 - if it is a reference is to a Method, the method is executed
 - if it is an assignment, the assignment is performed or the PropertySet function is run
4. if it is a reference, the result of step 3 is used to generate an empty result array with a suitable prototype by the application of the function `{Op=ω}` to it
5. the Class Destructor (if any) is run in the new Instance
6. the New Instance is deleted

Example

```

:Class Bird
  :Field Public Species

  ▽ egg spec
    :Access Public Instance
    :Implements Constructor
    □DF Species←spec
  ▽
  ▽ default
    :Access Public Instance
    :Implements Constructor
    □DF Species←'Default Bird'
    #.DISPLAY Species
  ▽
  ▽ R←Speak
    :Access Public
    #.DISPLAY R←'Tweet, Tweet, Tweet'
  ▽

:EndClass A Bird

```

First, we can create an empty array of Instances of Bird using `Op`.

```
Empty←Op□NEW Bird 'Robin'
```

A reference to `Empty.Species` causes APL to create a new Instance and invoke the niladic Constructor `default`. This function sets `Species` to `'Default Bird'` and calls `#.DISPLAY` which displays output to the Session.

```
DISPLAY Empty.Species
┌───────────┐
│Default Bird│
└───────────┘
```

APL then retrieves the value of `Species` (`'Default Bird'`), applies the function `{Op←ω}` to it and returns this as the result of the expression.

```
⊖──────────┐
┌──────────┐
│           │
└──────────┘
```

A reference to `Empty.Speak` causes APL to create a new Instance and invoke the niladic Constructor `default`. This function sets `Species` to `'Default Bird'` and calls `#.DISPLAY` which displays output to the Session.

```

      DISPLAY Empty.Speak
    → [Default Bird]

```

APL then invokes function `Speak` which displays `'Tweet, Tweet, Tweet'` and returns this as the result of the function.

```

    → [Tweet, Tweet, Tweet]

```

APL then applies the function `{Op←ω}` to it and returns this as the result of the expression.

```

    ⊖ [ ]

```

Base Constructors

Constructors in a Class hierarchy are not inherited in the same way as other members. However, there is a mechanism for all the Classes in the Class inheritance tree to participate in the initialisation of an Instance.

Every Constructor function contains a `:Implements Constructor` statement which may appear anywhere in the function body. The statement may optionally be followed by the `:Base` control word and an arbitrary expression.

The statement:

```

      :Implements Constructor :Base expr

```

calls a *monadic* Constructor in the Base Class. The choice of Constructor depends upon the rank and shape of the result of `expr` (see [Constructor Overloading on page 164](#) for details).

Whereas, the statement:

```

      :Implements Constructor

```

or

```

      :Implements Constructor :Base

```

calls the *niladic* Constructor in the Base Class.

Note that during the instantiation of an Instance, these calls potentially take place in every Class in the Class hierarchy.

If, anywhere down the hierarchy, there is a *monadic* call and there is no matching monadic Constructor, the operation fails with a **LENGTH ERROR**.

If there is a *niladic* call on a Class that defines **no Constructors**, the niladic call is simply repeated in the next Class along the hierarchy.

However, if a Class defines a monadic Constructor and no niladic Constructor it implies that that Class **cannot be instantiated without Constructor arguments**. Therefore, if there is a call to a niladic Constructor in such a Class, the operation fails with a **LENGTH ERROR**. Note that it is therefore impossible for APL to instantiate a fill item or process a reference to an empty array for such a Class or any Class that is based upon it.

A Constructor function may not call another Constructor function and a constructor function may not be called directly from outside the Class or Instance. The only way a Constructor function may be invoked is by **NEW**. The fundamental reason for these restrictions is that there must be one and only one call on the Base Constructor when a new Instance is instantiated. If Constructor functions were allowed to call one another, there would be several calls on the Base Constructor. Similarly, if a Constructor could be called directly it would potentially duplicate the Base Constructor call.

Niladic Example

In the following example, `DomesticParrot` is derived from `Parrot` which is derived from `Bird`. They all share the Field `Desc` (inherited from `Bird`). Each of the 3 Classes has its own *niladic* Constructor called `egg0`.

```
:Class Bird
  :Field Public Desc
  ▽ egg0
    :Access Public
    :Implements Constructor
    Desc←'Bird'
  ▽
:EndClass A Bird

:Class Parrot: Bird
  ▽ egg0
    :Access Public
    :Implements Constructor
    Desc,←'→Parrot'
  ▽
:EndClass A Parrot

:Class DomesticParrot: Parrot
  ▽ egg0
    :Access Public
    :Implements Constructor
    Desc,←'→DomesticParrot'
  ▽
:EndClass A DomesticParrot

(□NEW DomesticParrot).Desc
Bird→Parrot→DomesticParrot
```

Explanation

□NEW creates the new instance and runs the niladic Constructor `DomesticParrot.egg0`. As soon as the line:

```
:Implements Constructor
```

is encountered, □NEW calls the niladic constructor in the Base Class `Parrot.egg0`

`Parrot.egg0` starts to execute and as soon as the line:

```
:Implements Constructor
```

is encountered, □NEW calls the niladic constructor in the Base Class `Bird.egg0`.

When the line:

```
:Implements Constructor
```

is encountered, `NEW` cannot call the niladic constructor in the Base Class (there is none) so the chain of Constructors ends. Then, as the state indicator unwinds ...

Bird.egg0	executes	Desc←'Bird''
Parrot.egg0	executes	Desc,←'→Parrot''
DomesticParrot.egg0	execute	Desc,←'→DomesticParrot''

Monadic Example

In the following example, `DomesticParrot` is derived from `Parrot` which is derived from `Bird`. They all share the Field `Species` (inherited from `Bird`) but only a `DomesticParrot` has a Field `Name`. Each of the 3 Classes has its own Constructor called `egg`.

```
:Class Bird
  :Field Public Species
  ▽ egg spec
    :Access Public Instance
    :Implements Constructor
    Species←spec
  ▽
  ...
:EndClass A Bird

:Class Parrot: Bird
  ▽ egg species
    :Access Public Instance
    :Implements Constructor :Base 'Parrot: ',species
  ▽
  ...
:EndClass A Parrot

:Class DomesticParrot: Parrot
  :Field Public Name
  ▽ egg(name species)
    :Access Public Instance
    :Implements Constructor :Base species
    DF Name←name
  ▽
  ...
:EndClass A DomesticParrot
```

```

        pol←NEW DomesticParrot('Polly' 'Scarlet Macaw')
        pol.Name
Polly
        pol.Species
Parrot: Scarlet Macaw

```

Explanation

`NEW` creates the new instance and runs the Constructor `DomesticParrot.egg`. The `egg` header splits the argument into two items `name` and `species`. As soon as the line:

```
:Implements Constructor :Base species
```

is encountered, `NEW` calls the Base Class constructor `Parrot.egg`, passing it the result of the expression to the right, which in this case is simply the value in `species`.

`Parrot.egg` starts to execute and as soon as the line:

```
:Implements Constructor :Base 'Parrot: ',species
```

is encountered, `NEW` calls *its* Base Class constructor `Bird.egg`, passing it the result of the expression to the right, which in this case is the character vector `'Parrot: '` catenated with the value in `species`.

`Bird.egg` assigns its argument to the Public Field `Species`.

At this point, the state indicator would be:

```

        )SI
[#.[Instance of DomesticParrot]] #.Bird.egg[3]*
[constructor]
:base
[#.[Instance of DomesticParrot]] #.Parrot.egg[2]
[constructor]
:base
[#.[Instance of DomesticParrot]] #.DomesticParrot.egg[2]
[constructor]

```

`Bird.egg` then returns to `Parrot.egg` which returns to `DomesticParrot.egg`.

Finally, `DomesticParrot.egg[3]` is executed, which establishes Field `Name` and the Display Format (`DF`) for the instance.

Destructors

A *Destructor* is a function that is called just before an Instance of a Class ceases to exist and is typically used to close files or release external resources associated with an Instance.

An Instance of a Class is destroyed when:

- The Instance is expunged using `ⓘEX` or `)ERASE`.
- A function, in which the Instance is localised, exits.

But be aware that a destructor will also be called if:

- The Instance is re-assigned (see below)
- The result of `ⓘNEW` is not assigned (the instance gets created then immediately destroyed).
- APL creates (and then destroys) a new Instance as a result of a reference to a member of an empty Instance. The destructor is called after APL has obtained the appropriate value from the instance and no longer needs it.
- The constructor function fails. Note that the Instance is actually created before the constructor is run (inside it), and if the constructor fails, the fledgling Instance is discarded. Note too that this means a destructor *may* need to deal with a partially constructed instance, so the code may need to check that resources were actually acquired, before releasing them.
- On the execution of `)CLEAR`, `)LOAD`, `ⓘLOAD`, `)OFF` or `ⓘOFF`.

Warning: a Destructor may be executed on **any** thread.

Note that an Instance of a Class only disappears when the *last reference* to it disappears. For example, the sequence:

```
I1←ⓘNEW MyClass
I2←I1
)ERASE I1
```

will not cause the Instance of `MyClass` to disappear because it is still referenced by `I2`.

A Destructor is identified by the statement `:Implements Destructor` which must appear immediately after the function header in the Class script.

```

:Class Parrot
...
  ▽ kill
    :Implements Destructor
    'This Parrot is dead'
  ▽
...
:EndClass A Parrot

  pol←NEW Parrot 'Scarlet Macaw'
)ERASE pol
This Parrot is dead

```

Note that reassignment to `pol` causes the Instance referenced by `pol` to be destroyed and the Destructor invoked:

```

  pol←NEW Parrot 'Scarlet Macaw'
  pol←NEW Parrot 'Scarlet Macaw'
This Parrot is dead

```

If a Class inherits from another Class, the Destructor in its Base Class is automatically called after the Destructor in the Class itself.

So, if we have a Class structure: `DomesticParrot => Parrot => Bird` containing the following Destructors:

```

:Class DomesticParrot: Parrot
...
  ▽ kill
    :Implements Destructor
    'This ',(THIS),' is dead'
  ▽
...
:EndClass A DomesticParrot

:Class Parrot: Bird
...
  ▽ kill
    :Implements Destructor
    'This Parrot is dead'
  ▽
...
:EndClass A Parrot

```

```
:Class Bird
...
▽ kill
  :Implements Destructor
  'This Bird is dead'
▽
...
:EndClass A Bird
```

Destroying an Instance of `DomesticParrot` will run the Destructors in `DomesticParrot`, `Parrot` and `Bird` and in that order.

```
pol←NEW DomesticParrot

)CLEAR
This Polly is dead
This Parrot is dead
This Bird is dead
clear ws
```

Class Members

A Class may contain *Methods*, *Fields* and *Properties* (commonly referred to together as *Members*) which are defined within the body of the Class script or are inherited from other Classes.

Methods are regular APL defined functions, but with some special characteristics that control how they are called and where they are executed. Dfns may not be used as Methods.

Fields are just like APL variables. To get the Field value, you reference its name; to set the Field value, you assign to its name, and the Field value is stored *in* the Field. However, Fields differ from variables in that they possess characteristics that control their accessibility.

Properties are similar to APL variables. To get the Property value, you reference its name; to set the Property value, you assign to its name. However, Property values are actually accessed via *PropertyGet* and *PropertySet* functions that may perform all sorts of operations. In particular, the value of a Property is not stored *in* the Property and may be entirely dynamic.

All three types of member may be declared as *Public* or *Private* and as *Instance* or *Shared*.

Public members are visible from outside the Class and Instances of the Class, whereas Private members are only accessible from within.

Instance Members are unique to every Instance of the Class, whereas Shared Members are common to all Instances and Shared Members may be referenced directly on the Class itself.

Fields

A Field behaves just like an APL variable.

To get the value of a Field, you reference its name; to set the value of a Field, you assign to its name. Conceptually, the Field value is stored *in* the Field. However, Fields differ from variables in that they possess characteristics that control their accessibility.

A Field may be declared anywhere in a Class script by a `:Field` statement. This specifies:

- the name of the Field
- whether the Field is Public or Private
- whether the Field is Instance or Shared
- whether or not the Field is ReadOnly
- optionally, an initial value for the Field.

Note that [Triggers](#) may be associated with Fields. See [Trigger Fields on page 184](#) for details.

Public Fields

A *Public* Field may be accessed from outside an Instance or a Class. Note that the default is *Private*.

Class `DomesticParrot` has a `Name` Field which is defined to be Public and Instance (by default).

```
:Class DomesticParrot: Parrot
  :Field Public Name

  ▽ egg nm
    :Access Public
    :Implements Constructor
    Name←nm
  ▽
  ...
:EndClass A DomesticParrot
```

The `Name` field is initialised by the Class constructor.

```
pet←NEW DomesticParrot'Polly'
pet.Name
Polly
```

The `Name` field may also be modified directly:

```
pet.Name←φpet.Name
pet.Name
ylloP
```

Initialising Fields

A Field may be assigned an initial value. This can be specified by an arbitrary expression that is executed when the Class is fixed by the Editor or by `FIX`.

```
:Class DomesticParrot: Parrot
  :Field Public Name
  :Field Public Talks←1

  ▽ egg nm
  :Access Public
  :Implements Constructor
  Name←nm
  ▽
  ...
:EndClass A DomesticParrot
```

Field `Talks` will be initialised to `1` in every instance of the Class.

```
pet←NEW DomesticParrot 'Dicky'

pet.Talks
1
pet.Name
Dicky
```

Note that if a Field is `ReadOnly`, this is the only way that it may be assigned a value.

See also: [Shared Fields on page 183](#).

Private Fields

A Private Field may only be referenced by code running inside the Class or an Instance of the Class. Furthermore, Private Fields are not inherited.

The ComponentFile Class ([see page 196](#)) has a Private Instance Field named `tie` that is used to store the file tie number in each Instance of the Class.

```

:Class ComponentFile
  :Field Private Instance tie

  ▽ Open filename
    :Implements Constructor
    :Access Public Instance
    :Trap 0
      tie←filename □FTIE 0
    :Else
      tie←filename □FCREATE 0
    :EndTrap
    □DF filename, '(Component File)'
  ▽

```

As the field is declared to be Private, it is not accessible from outside an Instance of the Class, but is only visible to code running inside.

```

      F1←NEW ComponentFile 'test1'
      F1.tie
VALUE ERROR
      F1.tie
      ^

```

Shared Fields

If a Field is declared to be *Shared*, it has the same value for every Instance of the Class. Moreover, the Field may be accessed from the Class itself; an Instance is not required.

The following example establishes a Shared Field called `Months` that contains abbreviated month names which are appropriate for the user's current International settings. It also shows that an arbitrarily complex statement may be used to initialise a Field.

```
:Class Example
    :Using System.Globalization
    :Field Public Shared ReadOnly Months←12↑(NEW
DateTimeFormatInfo).AbbreviatedMonthNames
:EndClass A Example
```

A Shared Field is not only accessible from an instance...

```
EG←NEW Example
EG.Months
Jan Feb Mar Apr May Jun Jul Aug Sep Oct Nov...
```

... but also, directly from the Class itself.

```
Example.Months
Jan Feb Mar Apr May Jun Jul Aug Sep Oct Nov...
```

Notice that in this case it is necessary to insert a `:Using` statement (or the equivalent assignment to `USING`) in order to specify the .NET search path for the `DateTimeFormatInfo` type. Without this, the Class would fail to fix.

You can see how the assignment works by executing the same statements in the Session:

```
USING←'System.Globalization'
12↑(NEW DateTimeFormatInfo).AbbreviatedMonthNames
Jan Feb Mar Apr May Jun Jul Aug Sep Oct Nov...
```

Trigger Fields

A field may act as a [Trigger](#) so that a function may be invoked whenever the value of the Field is changed.

As an example, it is often useful for the Display Form of an Instance to reflect the value of a certain Field. Naturally, when the Field changes, it is desirable to change the Display Form. This can be achieved by making the Field a Trigger as illustrated by the following example.

Notice that the Trigger function is invoked both by assignments made within the Class (as in the assignment in `ctor`) and those made from outside the Instance.

```

:Class MyClass
  :Field Public Name
  :Field Public Country←'England'
  ▽ ctor nm
    :Access Public
    :Implements Constructor
    Name←nm
  ▽
  ▽ format
    :Implements Trigger Name,Country
    □DF'My name is ',Name,' and I live in ',Country
  ▽
:EndClass

me←NEW MyClass 'Pete'
me
My name is Pete and I live in England

me.Country←'Greece'
me
My name is Pete and I live in Greece

me.Name←'Kostas'
me
My name is Kostas and I live in Greece

```

Methods

Methods are implemented as regular defined functions, but with some special attributes that control how they are called and where they are executed.

A Method is defined by a contiguous block of statements in a Class Script. A Method begins with a line that contains a `▽`, followed by a valid APL defined function header. The method definition is terminated by a closing `▽`.

The behaviour of a Method is defined by an `:Access` control statement.

Public or Private

Methods may be defined to be Private (the default) or Public.

A Private method may only be invoked by another function that is running inside the Class namespace or inside an Instance namespace. The name of a Private method is not visible from outside the Class or an Instance of the Class.

A Public method may be called from outside the Class or an Instance of the Class.

Instance or Shared

Methods may be defined to be Instance (the default) or Shared.

An Instance method runs in the Instance namespace and may only be called via the instance itself. An Instance method has direct access to Fields and Properties, both Private and Public, in the Instance in which it runs.

A Shared method runs in the Class namespace and may be called via an Instance or via the Class. However, a Shared method that is called via an Instance does not have direct access to the Fields and Properties of that Instance.

Shared methods are typically used to manipulate Shared Properties and Fields or to provide general services for all Instances that are not Instance specific.

Overridable Methods

Instance Methods may be declared with `:Access Overridable`.

A Method declared as being Overridable is replaced in situ (i.e. within its own Class) by a Method of the same name that is defined in a higher Class which itself is declared with the Override keyword. See [Superseding Base Class Methods on page 188](#).

Shared Methods

A Shared method runs in the Class namespace and may be called via an Instance or via the Class. However, a Shared method that is called via an Instance does not have direct access to the Fields and Properties of that Instance.

Class `Parrot` has a `Speak` method that does not require any information about the current Instance, so may be declared as Shared.

```
:Class Parrot:Bird
    ▽ R←Speak times
      :Access Public Shared
      R←⌘times⌘'Squark!'
    ▽

:EndClass A Parrot

    wild←[]NEW Parrot
    wild.Speak 2
Squark! Squark!
```

Note that `Parrot.Speak` may be executed directly from the Class and does not in fact require an Instance.

```
    Parrot.Speak 3
Squark! Squark! Squark!
```

Instance Methods

An Instance method runs in the Instance namespace and may only be called via the instance itself. An Instance method has direct access to Fields and Properties, both Private and Public, in the Instance in which it runs.

Class `DomesticParrot` has a `Speak` method defined to be Public and Instance. Where `Speak` refers to `Name`, it obtains the value of `Name` in the current Instance.

Note too that `DomesticParrot.Speak` supersedes the inherited `Parrot.Speak`.

```

:Class DomesticParrot: Parrot
    :Field Public Name

    ▽ egg nm
        :Access Public
        :Implements Constructor
        Name←nm
    ▽

    ▽ R←Speak times
        :Access Public Instance
        R←Name, ', ', Name
        R←↑R, timespc' Who''s a pretty boy, then!'
    ▽

:EndClass A DomesticParrot

    pet←NEW DomesticParrot'Polly'
    pet.Speak 3
Polly, Polly
Who's a pretty boy, then!
Who's a pretty boy, then!
Who's a pretty boy, then!

    bil←NEW DomesticParrot'Billy'
    bil.Speak 1
Billy, Billy
Who's a pretty boy, then!

```

Superseding Base Class Methods

Normally, a Method defined in a higher Class supersedes the Method of the same name that is defined in its Base Class, but only for calls made from above or within the higher Class itself (or an Instance of the higher Class). The base method remains available **in the Base Class** and is invoked by a reference to it *from within the Base Class*. This behaviour can be altered using the `Overridable` and `Override` key words in the `:Access` statement but only applies to Instance Methods.

If a Public Instance method in a Class is marked as *Overridable*, this allows a Class which derives from the Class with the *Overridable* method to supersede the Base Class method *in the Base Class*, by providing a method which is marked *Override*. The typical use of this is to replace code in the Base Class which handles an event, with a method provided by the derived Class.

For example, the base class might have a method which is called if any error occurs in the base class:

```

[1]   ▽ ErrorHandler
[2]   :Access Public Overridable
[3]   □←↑□DM
[4]   ▽

```

In your derived class, you might supersede this by a more sophisticated error handler, which logs the error to a file:

```

[1]   ▽ ErrorHandler;TN
[2]   :Access Public Override
[3]   □←↑□DM
[4]   TN←'ErrorLog'□FSTIE 0
[5]   □DM □FAPPEND TN
[6]   □FUNTIE TN
[7]   ▽

```

If the derived class had a function which was not marked `Override`, then function in the derived class which called `ErrorHandler` would call the function as defined in the derived class, but if a function in the base class called `ErrorHandler`, it would still see the base class version of this function. With `Override` specified, the new function supersedes the function as seen by code in the base class. Note that different derived classes can specify different `Overrides`.

In C#, Java and some other compiled languages, the term *Virtual* is used in place of *Overridable*, which is the term used by Visual Basic and Dyalog APL.

Properties

A Property behaves in a very similar way to an ordinary APL variable. To obtain the value of a Property, you simply reference its name. To change the value of a Property, you assign a new value to the name.

However, *under the covers*, a Property is accessed via a *PropertyGet* function and its value is changed via a *PropertySet* function. Furthermore, Properties may be defined to allow partial (indexed) retrieval and assignment to occur.

There are three types of Property, namely *Simple*, *Numbered* and *Keyed*.

A *Simple Property* is one whose value is accessed (by APL) in its entirety and re-assigned (by APL) in its entirety.

A *Numbered Property* behaves like an array (conceptually a vector) which is only ever *partially* accessed and set (one element at a time) via indices. The Numbered Property is designed to allow APL to perform selections and structural operations on the Property.

A *Keyed Property* is similar to a Numbered Property except that its elements are accessed via arbitrary keys instead of indices.

The following cases illustrate the difference between Simple and Numbered Properties.

If Instance `MyInst` has a Simple Property `Sprop` and a Numbered Property `Nprop`, the expressions

```
X←MyInst.Sprop  
X←MyInst.Sprop[2]
```

both cause APL to call the `PropertyGet` function to retrieve the entire value of `Sprop`. The second statement subsequently uses indexing to extract just the second element of the value.

Whereas, the expression:

```
X←MyInst.Nprop[2]
```

causes APL to call the `PropertyGet` function with an additional argument which specifies that only the second element of the Property is required. Moreover, the expression:

```
X←MyInst.Nprop
```

causes APL to call the PropertyGet function successively, for every element of the Property.

A Property is defined by a `:Property ... :EndProperty` section in a Class Script.

Within the body of a Property Section there may be:

- one or more `:Access` statements which **must appear first** in the body of the Property.
- a single PropertyGet function.
- a single PropertySet function
- a single PropertyShape function

Simple Instance Properties

A Simple Instance Property is one whose value is accessed (by APL) in its entirety and re-assigned (by APL) in its entirety. The following examples are taken from the ComponentFile Class ([see page 196](#)).

The Simple Property `Count` returns the number of components on a file.

```

:Property Count
:Access Public Instance
  ▽ r←get
    r←-1+2>⊞FSIZE tie
  ▽
:EndProperty A Count

F1←⊞NEW ComponentFile 'test1'
F1.Append'Hello World'
1
F1.Count
1
F1.Append 42
2
F1.Count
2

```

Because there is no `set` function defined, the Property is read-only and attempting to change it causes `SYNTAX ERROR`.

```

F1.Count←99
SYNTAX ERROR
F1.Count←99
^

```

The `Access` Property has both `get` and `set` functions which are used, in this simple example, to get and set the component file access matrix.

```

:Property Access
:Access Public Instance
  ▽ r←get
  r←⊞FRDAC tie
  ▽
  ▽ set am;mat;OK
  mat←am.NewValue
  :Trap 0
  OK←(2=ppmat)^(3=2>pmat)^^/,mat=[mat
  :Else
  OK←0
  :EndTrap
  'bad arg'⊞SIGNAL(~OK)/11
  mat ⊞FSTAC tie
  ▽
:EndProperty A Access

```

Note that the `set` function **must** be monadic. Its argument, supplied by APL, will be an Instance of `PropertyArguments`. This is an internal Class whose `NewValue` field contains the value that was assigned to the Property.

Note that the set function does not have to accept the new value that has been assigned. The function may validate the value reject or accept it (as in this example), or perform whatever processing is appropriate.

```

F1←⊞NEW ComponentFile 'test1'
ρF1.Access
0 3
  F1.Access←3 3p28 2105 16385 0 2073 16385 31 ~1 0
  F1.Access
28 2105 16385
  0 2073 16385
31 ~1 0

  F1.Access←'junk'
bad arg
  F1.Access←'junk'
  ^

  F1.Access←1 2p10
bad arg
  F1.Access←1 2p10
  ^

```

Simple Shared Properties

The [ComponentFile Class](#) (see page 196) specifies a Simple Shared Property named `Files` which returns the names of all the Component Files in the current directory.

The previous examples have illustrated the use of Instance Properties. It is also possible to define *Shared* properties.

A Shared property may be used to handle information that is relevant to the Class as a whole, and which is not specific to any a particular Instance.

```

:Property Files
:Access Public Shared
  ▽ r←get
    r←[]FLIB''
  ▽
:EndProperty

```

Note that `[]FLIB` (invoked by the `Files get` function) does not report the names of *tied* files.

```

F1←[]NEW ComponentFile 'test1'
[]EX'F1'
F2←[]NEW ComponentFile 'test2'
F2.Files NB []FLIB does not report tied files
test1
[]EX'F2'

```

Note that a Shared Property may be accessed from the Class itself. It is not necessary to create an Instance first.

```

ComponentFile.Files
test1
test2

```

Numbered Properties

A Numbered Property behaves like an array (conceptually a vector) which is only ever *partially* accessed and set (one element at a time) via indices.

To implement a Numbered Property, you **must** specify a PropertyShape function and either or both a PropertyGet and PropertySet function.

When an expression references or makes an assignment to a Numbered Property, APL first calls its PropertyShape function which returns the dimensions of the Property. Note that the shape of the result of this function determines the *rank* of the Property.

If the expression uses indexing, APL checks that the index or indices are within the bounds of these dimensions, and then calls the PropertyGet or PropertySet function. If the expression specifies a single index, APL calls the PropertyGet or PropertySet function once. If the expression specifies multiple indices, APL calls the function successively.

If the expression references or assigns the entire Property (without indexing) APL generates a set of indices for every element of the Property and calls the PropertyGet or PropertySet function successively for every element in the Property.

Note that APL generates a **RANK ERROR** if an index contains the wrong number of elements or an **INDEX ERROR** if an index is out of bounds.

When APL calls a monadic PropertyGet or PropertySet function, it supplies an argument of type PropertyArguments.

Example

The [ComponentFile Class](#) (see page 196) specifies a Numbered Property named **Component** which represents the contents of a specified component on the file.

```

:Property Numbered Component
:Access Public Instance
  ▽ r←shape
    r←~1+2>⊞FSIZE tie
  ▽
  ▽ r←get arg
    r←⊞FREAD tie arg.Indexers
  ▽
  ▽ set arg
    arg.NewValue ⊞FREPLACE tie,arg.Indexers
  ▽
:EndProperty

```

```

      F1←NEW ComponentFile 'test1'
1 2 3 F1.Append"(15)×c14
      4 5
      F1.Count
5
      F1.Component[4]
      4 8 12 16
      4⇒F1.Component
      4 8 12 16
      (←4 3)[]F1.Component
      4 8 12 16 3 6 9 12

```

Referencing a Numbered Property in its entirety causes APL to call the `get` function successively for every element.

```

      F1.Component
1 2 3 4 2 4 6 8 3 6 9 12 4 8 12 16 5 10 15 20
      ((←4 3)[]F1.Component)←'Hello' 'World'
      F1.Component[3]
World

```

Attempting to access a Numbered Property with inappropriate indices generates an error:

```

      F1.Component[6]
INDEX ERROR
      F1.Component[6]
      ^
      F1.Component[1;2]
RANK ERROR
      F1.Component[1;2]
      ^

```

The Default Property

A single Numbered Property may be identified as the *Default* Property for the Class. If a Class has a Default Property, indexing with the `[]` primitive function and `[...]` indexing may be applied to the Property directly via a reference to the Class or Instance.

The Numbered Property example of the ComponentFile Class ([see page 196](#)) can be extended by adding the control word `Default` to the `:Property` statement for the `Component` Property.

Indexing may now be applied directly to the Instance `F1`. In essence, `F1[n]` is simply shorthand for `F1.Component[n]` and `n[]F1` is shorthand for `n[]F1.Component`

```

:Property Numbered Default Component
:Access Public Instance
  ▽ r←shape
    r←~1+2⇒[]FSIZE tie
  ▽
  ▽ r←get arg
    r←[]FREAD tie arg.Indexers
  ▽
  ▽ set arg
    arg.NewValue []FREPLACE tie,arg.Indexers
  ▽
:EndProperty

F1←[]NEW ComponentFile 'test1'
F1.Append"(i5)×c14
1 2 3 4 5
F1.Count
5

F1[4]
4 8 12 16
(c4 3)[]F1
4 8 12 16 3 6 9 12
((c4 3)[]F1)←'Hello' 'World'
F1[3]
World

```

Note however that this feature applies only to indexing.

```

4⇒F1
DOMAIN ERROR
4⇒F1
^

```

ComponentFile Class

```

:Class ComponentFile
  :Field Private Instance tie

  ▽ Open filename
    :Implements Constructor
    :Access Public Instance
    :Trap 0
      tie←filename □FTIE 0
    :Else
      tie←filename □FCREATE 0
    :EndTrap
    □DF filename,'(Component File)'
  ▽

  ▽ Close
    :Access Public Instance
    □FUNTIE tie
  ▽

  ▽ r←Append data
    :Access Public Instance
    r←data □FAPPEND tie
  ▽

  ▽ Replace(comp data)
    :Access Public Instance
    data □FREPLACE tie,comp
  ▽

  :Property Count
  :Access Public Instance
  ▽ r←get
    r←~1+2⇒□FSIZE tie
  ▽
  :EndProperty A Count

```

Component File Class Example (continued)

```

:Property Access
:Access Public Instance
  ▽ r←get arg
    r←[]FRDAC tie
  ▽
  ▽ set am;mat;OK
    mat←am.NewValue
    :Trap 0
      OK←(2=ppmat)^(3=2>pmat)^^/,mat=[mat
    :Else
      OK←0
    :EndTrap
    'bad arg'[]SIGNAL(~OK)/11
    mat []FSTAC tie
  ▽
:EndProperty R Access

:Property Files
:Access Public Shared
  ▽ r←get
    r←[]FLIB''
  ▽
:EndProperty

:Property Numbered Default Component
:Access Public Instance
  ▽ r←shape args
    r←~1+2>[]FSIZE tie
  ▽
  ▽ r←get arg
    r←c[]FREAD tie,arg.Indexers
  ▽
  ▽ set arg
    (>arg.NewValue)[]FREPLACE tie,arg.Indexers
  ▽
:EndProperty

▽ Delete file;tie
:Access Public Shared
tie←file []FTIE 0
file []FERASE tie
▽
:EndClass R Class ComponentFile

```

Keyed Properties

A Keyed Property is similar to a Numbered Property except that it may **only** be accessed by indexing (so-called square-bracket indexing) and indices are not restricted to integers but may be arbitrary arrays.

To implement a Keyed Property, only a **get** and/or a **set** function are required. APL does not attempt to validate or resolve the specified indices in any way, so does not require the presence of a **shape** function for the Property.

However, APL **does** check that the rank and lengths of the indices correspond to the rank and lengths of the array to the right of the assignment (for an indexed assignment) and the array returned by the get function (for an indexed reference). If the rank or shape of these arrays fails to conform to the rank or shape of the indices, APL will issue a **RANK ERROR** or **LENGTH ERROR**.

Note too that indices **may be elided**. If **KProp** is a Keyed Property of Instance **I1**, the following expressions are all valid.

```
I1.KProp
I1.KProp[]←10
I1.KProp[]←10
I1.KProp['One' 'Two';]←10
I1.KProp['One' 'Two']←10
```

When APL calls a monadic **get** or a **set** function, it supplies an argument of type **PropertyArguments**, which identifies which dimensions and indices were specified. See [PropertyArguments Class on page 233](#).

The **Sparse2** Class illustrates the implementation and use of a Keyed Property.

Sparse2 represents a 2-dimensional sparse array each of whose dimensions are indexed by arbitrary character keys. The sparse array is implemented as a Keyed Property named **Values**. The following expressions show how it might be used.

```
SA1←[]NEW Sparse2
SA1.Values[<'Widgets';<'Jan']←100
SA1.Values[<'Widgets';<'Jan']
100
SA1.Values['Widgets' 'Grommets';'Jan' 'Mar'
'Oct']←10×2 3π6
SA1.Values['Widgets' 'Grommets';'Jan' 'Mar' 'Oct']
10 20 30
40 50 60
SA1.Values[<'Widgets';'Jan' 'Oct']
10 30
SA1.Values['Grommets' 'Widgets';<'Oct']
60
30
```

Sparse2 Class Example

```

:Class Sparse2 A 2D Sparse Array
  :Field Private keys
  :Field Private values
  ▽ make
    :Access Public
    :Implements Constructor
    keys←0pc'' ''
    values←0
  ▽
  :Property Keyed Values
  :Access Public Instance
    ▽ v←get arg;k
      k←arg.Indexers
      □SIGNAL(2≠pk)/4
      k←fixkeys k
      v←(values,0)[keys:k]
    ▽
    ▽ set arg;new;k;v;n
      v←arg.NewValue
      k←arg.Indexers
      □SIGNAL(2≠pk)/4
      k←fixkeys k
      v←(pk)(p*(>1=p,v))v
      □SIGNAL((pk)≠pv)/5
      k v←,"k v
      :If v/new←~kεkeys
        values,←new/v
        keys,←new/k
        k v/←~←c~new
      :EndIf
      :If 0<pk
        values[keys:k]←v
      :EndIf
    ▽
  :EndProperty

  ▽ k←fixkeys k
    k←(2≠≡"k){,(c*α)ω}"k
    k←(o.{>,/c"α ω})/k
  ▽
:EndClass A 2D Sparse Array

```

Internally, `Sparse2` maintains a list of keys and a list of values which are initialised to empty arrays by its constructor.

When an indexed assignment is made, the `set` function receives a list of keys (indices) in `arg.Indexer` and values in `arg.NewValue`. The function updates the values of existing keys, and adds new keys and their values to the internal lists.

When an indexed reference is made, the `get` function receives a list of keys (indices) in `arg.Indexer`. The function uses these keys to retrieve the corresponding values, inserting 0s for non-existent keys.

Note that in the expression:

```
SA1.Values['Widgets' 'Grommets']; 'Jan' 'Mar' 'Oct']
```

the structure of `arg.Indexer` is:



Example

A second example of a Keyed Property is provided by the `KeyedFile` Class which is based upon the `ComponentFile` Class ([see page 196](#)) used previously.

```

:Class KeyedFile: ComponentFile
  :Field Public Keys
  □ML←0

  ▽ Open filename
  :Implements Constructor :Base filename
  :Access Public Instance
  :If Count>0
    Keys←{ω⇒□BASE.Component}”ιCount
  :Else
    Keys←0p<'
  :EndIf
  ▽

  :Property Keyed Component
  :Access Public Instance
  ▽ r←get arg;keys;sink
  keys↔arg.Indexers
  □SIGNAL(~^/keys∈Keys)/3
  r←{2>ω⇒□BASE.Component}”Keysιkeys
  ▽
  ▽ set arg;new;keys;vals
  vals←arg.NewValue
  keys↔arg.Indexers
  □SIGNAL((ρ,keys)≠ρ,vals)/5
  :If v/new←~keys∈Keys
    sink←Append”↓ϕ↑(←new)/”keys vals
    Keys,←new/keys
    keys vals/”←←~new
  :EndIf
  :If 0<ρ,keys
    Replace”↓ϕ↑(Keysιkeys)(↓ϕ↑keys vals)
  :EndIf
  ▽
  :EndProperty

:EndClass A Class KeyedFile

```

```

    K1←NEW KeyedFile 'ktest'
    K1.Count
0
    K1.Component[<'Pete']←42
    K1.Count
1
    K1.Component['John' 'Geoff']←(110)(3 4ρ12)
    K1.Count
3
    K1.Component['Geoff' 'Pete']
1 2 3 4 42
5 6 7 8
9 10 11 12
    K1.Component['Pete' 'Morten']←(3 4ρ'°')(113)
    K1.Count
4
    K1.Component['Morten' 'Pete' 'John']
1 1 1 1 1 2 1 1 3  ○○○○ 1 2 3 4 5 6 7 8 9 10
1 2 1 1 2 2 1 2 3  ○○○○
○○○○

```

Interfaces

An Interface is defined by a Script that contains skeleton declarations of Properties and/or Methods. These members are only *place-holders*; they have no specific implementation; this is provided by each of the Classes that support the Interface.

An Interface contains a collection of methods and properties that together represents a *protocol* that an application must follow in order to manipulate a Class in a particular way.

An example might be an Interface called Icompare that provides a single method (Compare) which compares two Instances of a Class, returning a value to indicate which of the two is greater than the other. A Class that implements Icompare must provide an appropriate Compare method, but every Class will have its own individual version of Compare. An application can then be written that sorts Instances of any Class that supports the ICompare Interface.

An Interface is implemented by a Class if it includes the name of the Interface in its :Class statement, and defines a corresponding set of the Methods and Properties that are declared in the Interface.

To implement a Method, a function defined in the Class must include a `:Implements Method` statement that maps it to the corresponding Method defined in the Interface:

```
:Implements Method <InterfaceName.MethodName>
```

Furthermore, the syntax of the function (whether it be result returning, monadic or niladic) must exactly match that of the method described in the Interface. The function name, however, need not be the same as that described in the Interface.

Similarly, to implement a Property the type (Simple, Numbered or Keyed) and syntax (defined by the presence or absence of a PropertyGet and PropertySet functions) must exactly match that of the property described in the Interface. The Property name, however, need not be the same as that described in the Interface.

Penguin Class Example

The Penguin Class example illustrates the use of Interfaces to implement *multiple inheritance*.

```
:Interface FishBehaviour
▽ R+Swim A Returns description of swimming capability
▽
:EndInterface A FishBehaviour

:Interface BirdBehaviour
▽ R+Fly A Returns description of flying capability
▽
▽ R+Lay A Returns description of egg-laying behaviour
▽
▽ R+Sing A Returns description of bird-song
▽
:EndInterface A BirdBehaviour
```

```

:Class Penguin: Animal,BirdBehaviour,FishBehaviour
  ▽ R←NoCanFly
    :Implements Method BirdBehaviour.Fly
    R←'Although I am a bird, I cannot fly'
  ▽
  ▽ R←LayOneEgg
    :Implements Method BirdBehaviour.Lay
    R←'I lay one egg every year'
  ▽
  ▽ R←Croak
    :Implements Method BirdBehaviour.Sing
    R←'Croak, Croak!'
  ▽
  ▽ R←Dive
    :Implements Method FishBehaviour.Swim
    R←'I can dive and swim like a fish'
  ▽
:EndClass A Penguin

```

In this case, the `Penguin` Class derives from `Animal` but additionally supports the `BirdBehaviour` and `FishBehaviour` Interfaces, thereby inheriting members from both.

```

Pingo←[]NEW Penguin
[]CLASS Pingo
#.Penguin #.FishBehaviour #.BirdBehaviour #.Animal

(FishBehaviour []CLASS Pingo).Swim
I can dive and swim like a fish
(BirdBehaviour []CLASS Pingo).Fly
Although I am a bird, I cannot fly
(BirdBehaviour []CLASS Pingo).Lay
I lay one egg every year
(BirdBehaviour []CLASS Pingo).Sing
Croak, Croak!

```

Including Namespaces in Classes

A Class may import methods from one or more plain Namespaces. This allows several Classes to share a common set of methods, and provides a degree of multiple inheritance.

To import methods from a Namespace **NS**, the Class Script must include a statement:

```
:Include NS
```

When the Class is fixed by the editor or by **FIX**, all the defined functions and operators in Namespace **NS** are included as methods in the Class. The functions and operators which are brought in as methods from the namespace **NS** are treated exactly as if the source of each function/operator had been included in the class script at the point of the **:Include** statement. For example, if a function contains **:Signature** or **:Access** statements, these will be taken into account. Note that such declarations have no effect on a function/operator which is in an ordinary namespace.

Dfns and dops in **NS** are also included in the Class but as *Private members*, because dfns and dops may not contain **:Signature** or **:Access** statements. Variables and Sub-namespaces in **NS** are **not** included.

Note that objects imported in this way are not actually *copied*, so there is no penalty incurred in using this feature. Additions, deletions and changes to the functions in **NS** are immediately reflected in the Class.

If there is a member in the Class with the same name as a function in **NS**, the Class member takes precedence and supersedes the function in **NS**.

Conversely, functions in **NS** will supersede members of the same name that are inherited from the Base Class, so the precedence is:

Class supersedes

Included Namespace, supersedes

Base Class

Any number of Namespaces may be included in a Class and the **:Include** statements may occur anywhere in the Class script. However, for the sake of readability, it is recommended that you have **:Include** statements at the top, given that any definitions in the script will supersede included functions and operators.

For information on copying classes that reference namespaces in this way, see *Programming Reference Guide: Copy System Command*.

Example

In this example, Class `Penguin` inherits from `Animal` and includes functions from the plain Namespaces `BirdStuff` and `FishStuff`.

```
:Class Penguin: Animal
  :Include BirdStuff
  :Include FishStuff
:EndClass A Penguin
```

Namespace `BirdStuff` contains 2 functions, both declared as Public methods.

```
:Namespace BirdStuff
  ▽ R+Fly
    :Access Public Instance
    R+'Fly, Fly ...'
  ▽
  ▽ R+Lay
    :Access Public Instance
    R+'Lay, Lay ...'
  ▽
:EndNamespace A BirdStuff
```

Namespace `FishStuff` contains a single function, also declared as a Public method.

```
:Namespace FishStuff
  ▽ R+Swim
    :Access Public Instance
    R+'Swim, Swim ...'
  ▽
:EndNamespace A FishStuff
```

```
    Pingo+[]NEW Penguin
    Pingo.Swim
Swim, Swim ...
    Pingo.Lay
Lay, Lay ...
    Pingo.Fly
Fly, Fly ...
```

This is getting silly - we all know that Penguin's can't fly. This problem is simply resolved by overriding the `BirdStuff.Fly` method with `Penguin.Fly`. We can hide `BirdStuff.Fly` with a Private method in `Penguin` that does nothing. For example:

```
:Class Penguin: Animal
  :Include BirdStuff
  :Include FishStuff
  ▽ Fly A Override BirdStuff.Fly
  ▽
:EndClass A Penguin

Pingo←NEW Penguin
Pingo.Fly
VALUE ERROR
Pingo.Fly
^
```

or we can supersede it with a different Public method, as follows:

```
:Class Penguin: Animal
  :Include BirdStuff
  :Include FishStuff
  ▽ R←Fly A Override BirdStuff.Fly
  :Access Public Instance
  R←'Sadly, I cannot fly'
  ▽
:EndClass A Penguin

Pingo←NEW Penguin
Pingo.Fly
Sadly, I cannot fly
```

Nested Classes

It is possible to define *Classes within Classes* (Nested Classes).

A Nested Class may be either **Private** or **Public**. This is specified by a `:Access` Statement, which must precede the definition of any Class contents. The default is **Private**.

A **Public** Nested Class is visible from outside its containing Class and may be used directly in its own right, whereas a **Private** Nested Class is not and may only be used by code inside the containing Class.

However, methods in the containing Class may return instances of Private Nested Classes and in that way expose them to the calling environment.

GolfService Example Class

```
:Class GolfService
:Using System

    :Field Private GOLFILE←'' A Name of Golf data file
    :Field Private GOLFID←0 A Tie number Golf data file

:Class GolfCourse
    :Field Public Code←-1
    :Field Public Name←''

    ▽ ctor args
        :Implements Constructor
        :Access Public Instance
        Code Name←args
        □DF Name, '(',(#Code), ')'
    ▽

:EndClass

:Class Slot
    :Field Public Time
    :Field Public Players

    ▽ ctor1 t
        :Implements Constructor
        :Access Public Instance
        Time←t
        Players←0p<'
    ▽
    ▽ ctor2 (t pl)
        :Implements Constructor
        :Access Public Instance
        Time Players←t pl
    ▽
    ▽ format
        :Implements Trigger Players
        □DF#Time Players
    ▽

:EndClass
```



```

:Class Booking
  :Field Public OK
  :Field Public Course
  :Field Public TeeTime
  :Field Public Message

  ▽ ctor args
    :Implements Constructor
    :Access Public Instance
    OK Course TeeTime Message←args
  ▽
  ▽ format
    :Implements Trigger OK,Message
    □DF#Course TeeTime(▷OKφMessage'OK')
  ▽
:EndClass

:Class StartingSheet
  :Field Public OK
  :Field Public Course
  :Field Public Date
  :Field Public Slots←□NULL
  :Field Public Message

  ▽ ctor args
    :Implements Constructor
    :Access Public Instance
    OK Course Date←args
  ▽
  ▽ format
    :Implements Trigger OK,Message
    □DF#2 1p(#Course Date)(†#''Slots)
  ▽
:EndClass

▽ ctor file
  :Implements Constructor
  :Access Public Instance
  GOLFILE←file
  □FUNTIE(((↓□FNAMES)~' ')ι<GOLFILE)▷□FNUMS,0
  :Trap 22
    GOLFID←GOLFILE □FTIE 0
  :Else
    InitFile
  :EndTrap
▽

```

```

▽ dtor
  :Implements Destructor
  □FUNTIE GOLFID
▽

▽ InitFile;COURSECODES;COURSES;INDEX;I
  :Access Public
  :If GOLFID≠0
    GOLFILE □FERASE GOLFID
  :EndIf
  GOLFID←GOLFILE □FCREATE 0
  COURSECODES←1 2 3
  COURSES←'St Andrews' 'Hindhead' 'Basingstoke'
  INDEX←(ρCOURSES)ρ0
  COURSECODES COURSES INDEX □FAPPEND GOLFID
  :For I :In ρCOURSES
    INDEX[I]←θ θ □FAPPEND 1
  :EndFor
  COURSECODES COURSES INDEX □FREPLACE GOLFID 1
▽

▽ R←GetCourses;COURSECODES;COURSES;INDEX
  :Access Public
  COURSECODES COURSES INDEX←□FREAD GOLFID 1
  R←{□NEW GolfCourse ω}''↓↓↑COURSECODES COURSES
▽

```

```

▽ R←GetStartingSheet
  ARGS;CODE;COURSE;DATE;COURSECODES
                                ;COURSES;INDEX;COURSEI;IDN
                                ;DATES;COMPS;IDATE;TEETIMES
                                ;GOLFERS;I;T

  :Access Public
  CODE DATE←ARGS
  COURSECODES COURSES INDEX←[]FREAD GOLFID 1
  COURSEI←COURSECODES⌊CODE
  COURSE←[]NEW GolfCourse(CODE(COURSEI⇒COURSES,←'))
  R←[]NEW StartingSheet(0 COURSE DATE)
  :If COURSEI>ρCOURSECODES
    R.Message←'Invalid course code'
    :Return
  :EndIf
  IDN←2 []NQ'. 'DateToIDN',DATE.(Year Month Day)
  DATES COMPS←[]FREAD GOLFID,COURSEI⇒INDEX
  IDATE←DATES⌊IDN
  :If IDATE>ρDATES
    R.Message←'No Starting Sheet available'
    :Return
  :EndIf
  TEETIMES GOLFERS←[]FREAD GOLFID,IDATE⇒COMPS
  T←DateTime.New''(←DATE.(Year Month Day)),''↓[1]
                                24 60 1τTEETIMES

  R.Slots←{[]NEW Slot ω}τT,←''↓GOLFERS
  R.OK←1

```

▽

```

▽ R←MakeBooking ARG$;CODE;COURSE;SLOT;TEETIME
    ; COURSECODES;COURSES;INDEX
    ; COURSEI;IDN;DATES;COMPS;IDATE
    ; TEETIMES;GOLFERS;OLD;COMP;HOURS
    ; MINUTES;NEAREST;TIME;NAMES;FREE
    ; FREETIMES;I;J;DIFF

:Access Public
A If GimmeNearest is 0, tries for specified time
A If GimmeNearest is 1, gets nearest time
CODE TEETIME NEAREST←3↑ARG$
COURSECODES COURSES INDEX←FREAD GOLFID 1
COURSEI←COURSECODES⌠CODE
COURSE←NEW GolfCourse(CODE(COURSEI⇒COURSES,c'))
SLOT←NEW Slot TEETIME
R←NEW Booking(0 COURSE SLOT'')
:If COURSEI>ρCOURSECODES
    R.Message←'Invalid course code'
    :Return
:EndIf
:If TEETIME.Now>TEETIME
    R.Message←'Requested tee-time is in the past'
    :Return
:EndIf
:If TEETIME>TEETIME.Now.AddDays 30
    R.Message←'Requested tee-time is more than 30
                days from now'
    :Return
:EndIf
IDN←2 ρNQ'. 'DateToIDN',TEETIME.(Year Month Day)
DATES COMPS←FREAD GOLFID,COURSEI⇒INDEX
IDATE←DATES⌠IDN
:If IDATE>ρDATES
    TEETIMES←(24 60⌠7 0)+10×-1⌠1+8×6
    GOLFERS←((ρTEETIMES),4)ρ<'llowed per tee time
    :If 0=OLD↔(DATES<2 ρNQ'. 'DateToIDN',3↑TS)/
                ⌠ρDATES
        COMP←(TEETIMES GOLFERS)FAPPEND GOLFID
        DATES,←IDN
        COMPS,←COMP
        (DATES COMPS)FREPLACE GOLFID,COURSEI⇒INDEX
:Else
    DATES[OLD]←IDN
    (TEETIMES GOLFERS)FREPLACE GOLFID,
        COMP←OLD⇒COMPS
    DATES COMPS FREPLACE GOLFID,COURSEI⇒INDEX
:EndIf

```

```

        :Else
        COMP←IDATE▷COMPS
        TEETIMES GOLFERS←[]FREAD GOLFFID COMP
    :EndIf
    HOURS MINUTES←TEETIME.(Hour Minute)
    NAMES←(3↓ARGS)~θ'
    TIME←24 60⊥HOURS MINUTES
    TIME←10×⌊0.5+TIME÷10
    :If ~NEAREST
        I←TEETIMES⊥TIME
        :If I>ρTEETIMES
        :OrIf (ρNAMES)>▷,/+/0=ρ''GOLFERS[I;]
            R.Message←'Not available'
            :Return
        :EndIf
    :Else
        :If ~√/FREE←(ρNAMES)≤▷,/+/0=ρ''GOLFERS
            R.Message←'Not available'
            :Return
        :EndIf
        FREETIMES←(FREE×TEETIMES)+32767×~FREE
        DIFF←|FREETIMES-TIME
        I←DIFF⊥|/DIFF
    :EndIf
    J←(▷, /0=ρ''GOLFERS[I;])/⊥4
    GOLFERS[I;(ρNAMES)↑J]←NAMES
    (TEETIMES GOLFERS)[]FREPLACE GOLFFID COMP
    TEETIME←DateTime.New TEETIME.(Year Month Day),
        3↑24 60⊥I▷TEETIMES

    SLOT.Time←TEETIME
    SLOT.Players←(▷, /0<ρ''GOLFERS[I;])/GOLFERS[I;]
    R.(OK TeeTime)←1 SLOT
    ▽
:EndClass

```

GolfService Example

The GolfService Example Class illustrates the use of nested classes. GolfService was originally developed as a Web Service for Dyalog.NET and is one of the samples distributed in `samples\asp.net\webservices`. This version has been reconstructed as a stand-alone APL Class.

GolfService contains the following nested classes, all of which are **Private**.

GolfCourse	A Class that represents a Golf Course, having Fields Code and Name .
Slot	A Class that represents a tee-time or match, having Fields Time and Players . Up to 4 players may play together in a match.
Booking	A Class that represents a reservation for a particular tee-time at a particular golf course. This has Fields OK , Course , TeeTime and Message . The value of TeeTime is an Instance of a Slot Class.
StartingSheet	A Class that represents a day's starting-sheet at a particular golf course. It has Fields OK , Course , Date , Slots , Message . Slots is an array of Instances of Slot Class.

The GolfService constructor takes the name of a file in which all the data is stored. This file is initialised by method **InitFile** if it doesn't already exist.

```
G←NEW GolfService 'F:\HELP11.0\GOLFDATA'
G
#. [Instance of GolfService]
```

The GetCourses method returns an array of Instances of the internal (nested) Class GolfCourse. Notice how the display form of each Instance is established by the GolfCourse constructor, to obtain the output display shown below.

```
G.GetCourses
St Andrews(1) Hindhead(2) Basingstoke(3)
```

All of the dates and times employ instances of the .NET type System.DateTime, and the following statements just set up some temporary variables for convenience later.

```
←Tomorrow←(NEW DateTime(3↑TS)).AddDays 1
31/03/2006 00:00:00
←TomorrowAt7←Tomorrow.AddHours 7
31/03/2006 07:00:00
```

The MakeBooking method takes between 4 and 7 parameters viz.

- the code for the golf course at which the reservation is required
- the date and time of the reservation
- a flag to indicate whether or not the nearest available time will do
- a list of up to 4 players who wish to book that time.

The result is an Instance of the internal Class Booking. Once again, `DF` is used to make the default display of these Instances meaningful. In this case, the reservation is successful.

```
G.MakeBooking 2 TomorrowAt7 1 'Pete' 'Tiger'
Hindhead(2) 31/03/2006 07:00:00 Pete Tiger OK
```

Bob, Arnie and Jack also ask to play at 7:00 but are given the 7:10 tee-time instead (4-player restriction).

```
G.MakeBooking 2 TomorrowAt7 1 'Bob' 'Arnie' 'Jack'
Hindhead(2) 31/03/2006 07:10:00 Bob Arnie Jack
OK
```

However, Pete and Tiger are joined at 7:00 by Dave and Al.

```
G.MakeBooking 2 TomorrowAt7 1 'Dave' 'Al'
Hindhead(2) 31/03/2006 07:00:00 Pete Tiger Dave
Al OK
```

Up to now, all bookings have been made with the tee-time flexibility flag set to 1. Inflexible Jim is only interested in playing at 7:00...

```
G.MakeBooking 2 TomorrowAt7 0 'Jim'
Hindhead(2) 31/03/2006 07:00:00 Not available
```

... so his reservation fails (4-player restriction).

Finally the GetStartingSheet method is used to obtain an Instance of the internal Class StartingSheet for the given course and day.

```
G.GetStartingSheet 2 Tomorrow
Hindhead(2) 31/03/2006 00:00:00
31/03/2006 07:00:00 Pete Tiger Dave Al
31/03/2006 07:10:00 Bob Arnie Jack
31/03/2006 07:20:00
....
```

Namespace Scripts

A Namespace Script is a script that begins with a `:Namespace` statement and ends with a `:EndNamespace` statement. When a Namespace Script is fixed, it establishes an entire namespace that may contain other namespaces, functions, variables and classes.

The names of Classes defined within a Namespace Script which are parents, children, or siblings are visible both to one another and to code and expressions defined in the same script, regardless of the namespace hierarchy within it. Names of Classes which are nieces or nephews and their descendants are however not visible.

For example:

```

:Namespace a

  d←[]NEW a1
  e←[]NEW bb2

  :Class a1
    ▽ r←foo
      :Access Shared Public
      r←[]NEW''b1 b2
    ▽
  :EndClass A a1

  ▽ r←goo
  r←a1.foo
  ▽

  ▽ r←foo
  r←[]NEW''b1 b2
  ▽

  :Namespace b
    :Class b1
    :EndClass A b1
    :Class b2
      :Class bb2
      :EndClass A bb2
    :EndClass A b2
  :EndNamespace A b

:EndNamespace A a

```



```

    a.d
#.a.[a1]
    a.e
#.a.[bb2]
    a.foo
#.a.[b1] #.a.[b2]

```

Note that the names of Classes **b1** (**a.b.b1**) and **b2** (**a.b.b2**) are not visible from their "uncle" **a1** (**a.a1**).

```

    a.goo
VALUE ERROR
foo[2] r+[]NEW''b1 b2

```

Notice that Classes in a Namespace Script are fixed before other objects (hence the assignments to **d** and **e** are evaluated *after* Classes **a1** and **bb2** are fixed), although the order in which Classes themselves are defined is still important if they reference one another during initialisation.

Changing Scripted Objects Dynamically

The source of a scripted object can only be altered using the Editor, or by refixing it in its entirety using **FIX**. Dynamic changes to variables, fields and properties, and calling **FIX** to generate functions do not alter the source of a scripted object.

Furthermore, if you introduce new objects of any type (functions, variables, or classes) into a namespace or a class defined by a script by any means other than editing the script, then these objects will be lost the next time the script is edited and fixed.

If you fix a function using **FIX** with the same name as a function defined in the script, this new version will supercede the version defined from the script, although the version in the script will remain unchanged.

If you edit the function (as opposed to editing the script) the Editor will show the new version of the function.

If however you edit the script, the Editor will display the original version of the function embedded in the script.

If you were to edit both the script and the function, the Editor would show the two different versions of the function as illustrated in the example that follows.

When you fix the script, the version of the function in the script will replace the one created using **FIX**.

Example

```

:Namespace ns
  ▾ foo
    1
  ▾
:EndNamespace

1      ns.foo

      ns.[FX 'foo' '2'
2      ns.foo

      )ed ns.foo ns

```

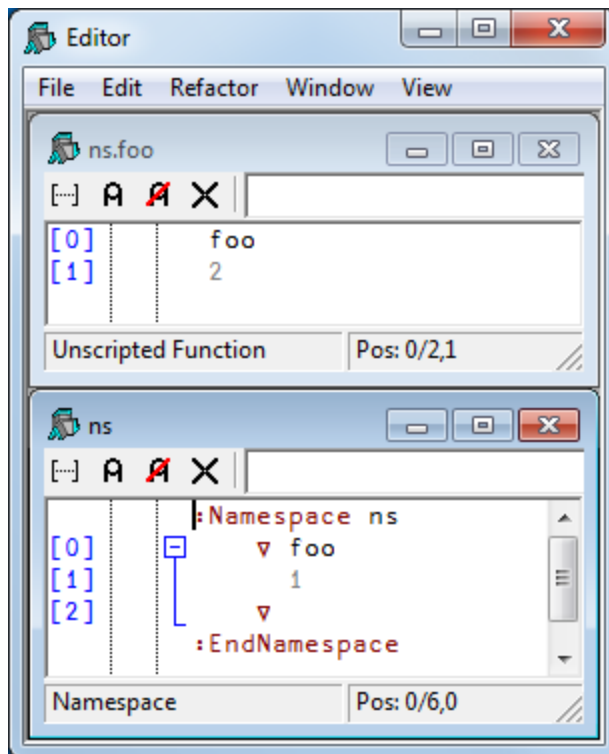

Note that the Editor displays the description **Unscripted Function** in the status bar of the window showing the new version of **foo**.

Similarly, if you were to Trace the execution of **ns.foo**, the Tracer would display the current (**[FX'ed**) version of **foo**, with the same description in its status bar.

Namespace Script Example

The DiaryStuff example illustrates the manner in which classes may be defined and used in a Namespace script.

DiaryStuff defines two Classes named `Diary` and `DiaryEntry`.

`Diary` contains a (private) Field named `entries`, which is simply a vector of instances of `DiaryEntry`. These are 2-element vectors containing a .NET DateTime object and a description.

The `entries` Field is initialised to an empty vector of `DiaryEntry` instances which causes the invocation of the default constructor `DiaryEntry.Make0` when `Diary` is fixed. See [Empty Arrays of Instances: Why? on page 168](#) for further explanation.

The `entries` Field is referenced through the `Entry` Property, which is defined as the Default Property. This allows individual entries to be referenced and changed using indexing on a `Diary` Instance.

Note that `DiaryEntry` is defined in the script first (before `Diary`) because it is referenced by the initialisation of the `Diaries.entries` Field

```
:Namespace DiaryStuff
:Using System

:Class DiaryEntry
:Field Public When
:Field Public What
▽ Make(ymdhm wot)
:Access Public
:Implements Constructor
When What←(NEW DateTime(6†5†ymdhm))wot
□DF‡When What
▽
▽ Make0
:Access Public
:Implements Constructor
When What←NULL''
▽
:EndClass A DiaryEntry
```

```
:Class Diary
:Field Private entries←0p[]NEW DiaryEntry
▽ R←Add(ymdhm wot)
:Access Public
R←[]NEW DiaryEntry(ymdhm wot)
entries,←R
▽
▽ R←DoingOn ymd;X
:Access Public
X←,(tentries.When.(Year Month Day))^.=3 1p3tymd
R←X/entries
▽
▽ R←Remove ymdhm;X
:Access Public
:If R←v/X←entries.When=[]NEW DateTime(6t5tymdhm)
entries←(~X)/entries
:EndIf
▽
:Property Numbered Default Entry
▽ R←Shape
R←pentries
▽
▽ R←Get arg
R←arg.Indexers>entries
▽
▽ Set arg
entries[arg.Indexers]←arg.NewValue
▽
:EndProperty
:EndClass A Diary

:EndNamespace
```

Create a new instance of `Diary`.

```
D ← NEW DiaryStuff.Diary
```

Add a new entry "meeting with John at 09:00 on April 30th"

```
D.Add(2006 4 30 9 0)'Meeting with John'
30/04/2006 09:00:00 Meeting with John
```

Add another diary entry "Dentist at 10:00 on April 30th".

```
D.Add(2006 4 30 10 0)'Dentist'
30/04/2006 10:00:00 Dentist
```

One of the benefits of the Namespace Script is that Classes defined within it (which are typically *related*) may be used *independently*, so we can create a stand-alone instance of `DiaryEntry`; "Doctor at 11:00"...

```
Doc ← NEW DiaryStuff.DiaryEntry((2006 4 30 11
0)'Doctor')
Doc
30/04/2006 11:00:00 Doctor
```

... and then use it to replace the second Diary entry with indexing:

```
D[2] ← Doc
```

and just to confirm it is there...

```
D[2]
30/04/2006 11:00:00 Doctor
```

What am I doing on the 30th?

```
D.DoingOn 2006 4 30
30/04/2006 09:00:00 Meeting with John ...
... 30/04/2006 11:00:00 Doctor
```

Remove the 11:00 appointment...

```
D.Remove 2006 4 30 11 0
1
```

and the complete Diary is...

```
D
30/04/2006 09:00:00 Meeting with John
```

Including Script Files in Scripts

A Class or Namespace script in the workspace or in a script file may specify that other script files are to be loaded prior to the fixing of the script itself. To do so, it must begin with one or more `:Require` statements, with the following syntax:

```
:Require file://[path]/file
```

If no `path` is specified, the path is taken to be relative to the current script file or, if in a workspace script, the current working directory. Note that a leading `'./'` or `'.\'` in `path` is not allowed, to avoid any potential confusion with "current directory".

`:Require` is a directive to the Editor (more specifically, to the internal mechanism that fixes a script as an object in the workspace) and can appear in any script containing APL code, but **must** precede all code in the script. `:Require` is thus not valid within a function, class, namespace or any other definition.

The prefix `file://` allows for the possibility of a future extension of `http://` and `ftp://`.

In version 17.1 `A!:require` is a synonym for `:Require`. This allows the user to create scripts which can be used in multiple versions of Dyalog; in 14.1 and earlier SALT parses `A!:require` statements and loads the appropriate files, in 17.1 it is the interpreter that loads the file named in `A!:require` statements. Dyalog intends to remove support for the `A!:require` statement from the interpreter in a future version. Note that unlike `:Require`, `A!:require` can appear within code.

Class Declaration Statements

This section summarises the various declaration statements that may be included in a Class or Namespace Script. For information on other declaration statements, as they apply to functions and methods, see [Function Declaration Statements on page 84](#).

:Interface Statement

```
:Interface <interface name>  
...  
:EndInterface
```

An Interface is defined by a Script containing skeleton declarations of Properties and/or Methods. The script must begin with a **:Interface Statement** and end with a **:EndInterface Statement**.

An Interface may not contain Fields.

Properties and Methods defined in an Interface, and the Class functions that implement the Interface, **may not** contain **:Access Statements**.

:Namespace Statement

```
:Namespace <namespace name>  
...  
:EndNamespace
```

A Namespace Script may be used to define an entire namespace containing other namespaces, functions, variables and Classes.

A Namespace script must begin with a **:Namespace** statement and end with a **:EndNamespace** statement.

Sub-namespaces, which may be nested, are defined by pairs of **:Namespace** and **:EndNamespace** statements within the Namespace script.

Classes are defined by pairs of **:Class** and **:EndClass** statements within the Namespace script, and these too may be nested.

The names of Classes defined within a Namespace Script are visible both to one another and to code and expressions defined in the same script, regardless of the namespace hierarchy within it.

A Namespace script is therefore particularly useful to group together Classes that refer to one another where the use of nested classes is inappropriate.

:Class Statement

```

:Class <class name><:base class name> <,interface name...>
:Include <namespace>
...
:EndClass

```

A class script begins with a **:Class** statement and ends with a **:EndClass** statement. The elements that comprise the **:Class** statement are as follows:

Element	Description
class name	Optionally, specifies the name of the Class, which must conform to the rules governing APL names.
base class name	Optionally specifies the name of a Class from which this Class is derived and whose members this Class inherits.
interface name	The names of one or more Interfaces which this Class supports.

A Class may import methods defined in separate plain Namespaces with one or more **:Include** statements. For further details, see [Including Namespaces in Classes on page 205](#).

Examples:

The following statements define a Class named **Penguin** that derives from (is based upon) a Class named **Animal** and which supports two Interfaces named **BirdBehaviour** and **FishBehaviour**.

```

:Class Penguin: Animal,BirdBehaviour,FishBehaviour
...
:EndClass

```

The following statements define a Class named **Penguin** that derives from (is based upon) a Class named **Animal** and includes methods defined in two separate Namespaces named **BirdStuff** and **FishStuff**.

```

:Class Penguin: Animal
:Include BirdStuff
:Include FishStuff
...
:EndClass

```

:Using Statement

```
:Using <NameSpace[,Assembly]>
```

This statement specifies a .NET namespace that is to be searched to resolve unqualified names of .NET types referenced by expressions in the Class.

Element	Description
NameSpace	Specifies a .NET namespace.
Assembly	Specifies the Assembly in which NameSpace is located. If the Assembly is located in the Microsoft.NET installation directory, you need only specify its name. If not, you must specify a full or relative pathname.

If the Microsoft .NET Framework is installed, the System namespace in `microsoft.dll` is automatically loaded when Dyalog APL starts. To access this namespace, it is not necessary to specify the name of the Assembly.

When the class is fixed, `USING` is inherited from the surrounding space. Each `:Using` statement appends an element to `USING`, with the exception of `:Using` with no argument:

If you omit `<NameSpace>`, this is equivalent to clearing `USING`, which means that no .NET namespaces will be searched (unless you follow this statement with additional `:Using` statements, each of which will append to `USING`).

To set `USING` to a single empty character vector, which only allows references to fully qualified names of classes in `microsoft.dll`, you must write:

```
:Using , (note the presence of the comma)
```

or

```
:Using ,microsoft.dll
```

i.e. specify an empty namespace name followed by no assembly, or followed by the default assembly, which is always loaded.

:Attribute Statement

```
:Attribute <Name> [ConstructorArgs]
```

The :Attribute statement is used to attach .NET Attributes to a Class or a Method.

Attributes are descriptive tags that provide additional information about programming elements. Attributes are not used by Dyalog APL but other applications can refer to the extra information in attributes to determine how these items can be used. Attributes are saved with the *metadata* of Dyalog APL .NET assemblies.

Element	Description
Name	The name of a .NET attribute
ConstructorArgs	Optional arguments for the Attribute constructor

Example

The following Class has `SerializableAttribute` and `CLSCompliantAttribute` attributes attached to the Class as a whole, and `ObsoleteAttribute` attributes attached to Methods `foo` and `goo` within it.

```
:Class c1
:using System
    :attribute SerializableAttribute
    :attribute CLSCompliantAttribute 1

    ▽ foo(p1 p2)
        :Access public instance
        :Signature foo Object,Object
        :Attribute ObsoleteAttribute
    ▽

    ▽ goo(p1 p2)
        :Access public instance
        :Signature goo Object,Object
        :Attribute ObsoleteAttribute 'Don''t use this' 1
    ▽

:EndClass A c1
```

When this Class is exported as a .NET Class, the attributes are saved in its metadata. For example, Visual Studio will warn developers if they make use of a member which has the `ObsoleteAttribute`.

:Access Statement

```
:Access <Private|Public><Instance|Shared><Overridable>
                                     <Override>
:Access <WebMethod>
```

The :Access statement is used to specify characteristics for Classes, Properties and Methods.

Element	Description
<code>Private Public</code>	Specifies whether or not the (nested) Class, Property or Method is accessible from outside the Class or an Instance of the Class. The default is <code>Private</code> .
<code>Instance Shared</code>	For a Field, specifies if there is a separate value of the Field in each Instance of the Class, or if there is only a single value that is shared between all Instances. For a Property or Method, specifies whether the code associated with the Property or Method runs in the Class or Instance.
<code>WebMethod</code>	Applies only to a Method and specifies that the method is exported as a web method. This applies only to a Class that implements a Web Service.
<code>Overridable</code>	Applies only to an Instance Method and specifies that the Method may be overridden by a Method in a higher Class. See below.
<code>Override</code>	Applies only to an Instance Method and specifies that the Method overrides the corresponding Overridable Method defined in the Base Class. See below.

Overridable/Override

Normally, a Method defined in a higher Class replaces a Method of the same name that is defined in its Base Class, but only for calls made from above or within the higher Class itself (or an Instance of the higher Class). The base method remains available *in the Base Class* and is invoked by a reference to it *from within the Base Class*.

However, a Method declared as being **Overridable** is replaced in situ (i.e. within its own Class) by a Method of the same name in a higher Class if that Method is itself declared with the **Override** keyword. For further information, see [Superseding Base Class Methods on page 188](#).

Nested Classes

The **:Access** statement is also used to control the visibility of one Class that is defined within another (a nested Class). A Nested Class may be either **Private** or **Public**. Note that the **:Access** Statement must precede the definition of any Class contents.

A **Public** Nested Class is visible from outside its containing Class and may be used directly in its own right, whereas a **Private** Nested Class is not and may only be used by code inside the containing Class.

However, methods in the containing Class may return instances of Private Nested Classes and in that way expose them to the calling environment.

WebMethod

Note that **:Access WebMethod** is equivalent to:

```
:Access Public  
:Attribute System.Web.Services.WebMethodAttribute
```

:Implements Statement

The `:Implements` statement identifies the function to be one of the following types.

```

:Implements Constructor <[:Base expr]>
:Implements Destructor
:Implements Method <InterfaceName.MethodName>
:Implements Trigger <name1><,name2,name3,...>
:Implements Trigger *

```

Element	Description
Constructor	Specifies that the function is a Class Constructor .
:Base expr	Specifies that the Base Constructor be called with the result of the expression expr as its argument.
Destructor	Specifies that the function is a Class Destructor .
Method	Specifies that the function implements the Method <code>MethodName</code> whose syntax is specified by Interface InterfaceName .
Trigger	Identifies the function as a Trigger Function which is activated by changes to variable <code>name1</code> , <code>name2</code> , and so forth. Trigger * specifies a Global Trigger that is activated by the assignment of any global variable in the same namespace.

:Field Statement

```
:Field <Private|Public> <Instance|Shared> <ReadOnly>...
... fieldName <← expr>
```

A `:Field` statement is a single statement whose elements are as follows:

Element	Description
<code>Private Public</code>	Specifies whether or not the Field is accessible from outside the Class or an Instance of the Class. The default is <code>Private</code> .
<code>Instance Shared</code>	Specifies if there is a separate value of the Field in each Instance of the Class, or if there is only a single value that is shared between all Instances.
<code>ReadOnly</code>	If specified, this keyword prevents the value in the Field from being changed after initialisation.
<code>FieldName</code>	Specifies the name of the Field (mandatory).
<code>← expr</code>	Specifies an initial value for the Field.

Examples:

The following statement defines a Field called `Name`. It is (by default), an Instance Field so every Instance of the Class has a separate value. It is a Public Field and so may be accessed (set or retrieved) from outside an Instance.

```
:Field Public Name
```

The following statement defines a Field called `Months`.

```
:Field Shared ReadOnly Months←12↑(NEW
DateTimeFormatInfo)
    .AbbreviatedMonthNames
```

`Months` is a Shared Field so there is just a single value that is the same for every Instance of the Class. It is (by default), a Private Field and may only be referenced by code running in an Instance or in the Class itself. Furthermore, it is `ReadOnly` and may not be altered after initialisation. Its initial value is calculated by an expression that obtains the short month names that are appropriate for the current locale using the .NET Type `DateTimeFormatInfo`.

Notes

Note that Fields are initialised when a Class script is fixed by the editor or by `FIX`. If the evaluation of `expr` causes an error (for example, a `VALUE ERROR`), an appropriate message will be displayed in the Status Window and `FIX` will fail with a `DOMAIN ERROR`. Note that a ReadOnly Field may only be assigned a value by its `:Field` statement.

In the second example above, the expression will only succeed if `USING` is set to the appropriate path, in this case `System.Globalization`.

You may not define a Field with the name of one of the permissible keywords (such as `public`). In such cases the Class will not fix and an error message will be displayed in the Status Window. For example:

```
error AC0541: a field must have a name " :Field Public public"
```

:Property Section

A Property is defined by a `:Property ... :EndProperty` section in a Class Script. The syntax of the `:Property` Statement, and its optional `:Access` statement is as follows:

```
:Property <Simple|Numbered|Keyed> <Default>
Name< ,Name>...
:Access <Private|Public><Instance|Shared>
...
:EndProperty
```

Element	Description
<code>Name</code>	Specifies the name of the Property by which it is accessed. Additional Properties, sharing the same PropertyGet and/or PropertySet functions, and the same access behaviour may be specified by a comma-separated list of names.
<code>Simple Numbered Keyed</code>	Specifies the type of Property (see below). The default is <code>Simple</code> .
<code>Default</code>	Specifies that this Property acts as the default property for the Class when indexing is applied directly to an Instance of the Class.
<code>Private Public</code>	Specifies whether or not the Property is accessible from outside the Class or an Instance of the Class. The default is <code>Private</code> .
<code>Instance Shared</code>	Specifies if there is a separate value of the Property in each Instance of the Class, or if there is only a single value that is shared between all Instances.

A Simple Property is one whose value is accessed (by APL) in its entirety and re-assigned (by APL) in its entirety.

A Numbered Property behaves like an array (conceptually a vector) which is only ever *partially* accessed and set (one element at a time) via indices.

A Keyed Property is similar to a Numbered Property except that its elements are accessed via arbitrary keys instead of indices.

Numbered and Keyed Properties are designed to allow APL to perform selections and structural operations on the Property.

Within the body of a Property Section there may be:

- one or more `:Access` statements
- a single `PropertyGet` function.
- a single `PropertySet` function
- a single `PropertyShape` function

The three functions are identified by case-independent names `Get`, `Set` and `Shape`.

Errors

When a Class is fixed by the Editor or by `FIX`, APL checks the validity of each Property section and the syntax of `PropertyGet`, `PropertySet` and `PropertyShape` functions within them.

- You may not specify a name which is the same as one of the keywords.
- There must be at least a `PropertyGet`, or a `PropertySet` or a `PropertyShape` function defined.
- You may only define a `PropertyShape` function if the Property is Numbered.

If anything is wrong, the Class is not fixed and an error message is displayed in the Status Window. For example:

```
error AC0545: invalid or empty property declaration
error AC0595: this property type should not implement a
"shape" function
```

PropertyArguments Class

Where appropriate, APL supplies the `PropertyGet` and `PropertySet` functions with an argument that is an instance of the internal class `PropertyArguments`.

`PropertyArguments` has just 3 read-only Fields which are as follows:

<code>Name</code>	The name of the property. This is useful when one function is handling several properties.
<code>NewValue</code>	Array containing the new value for the Property or for selected element(s) of the property as specified by <code>Indexers</code> .
<code>IndexersSpecified</code>	A Boolean vector that identifies which dimensions of the Property are to be referenced or assigned.
<code>Indexers</code>	A vector that identifies the elements of the Property that are to be referenced or assigned.

PropertyGet Function

$$R \leftarrow \text{Get } \{ipa\}$$

The name of the PropertyGet function must be `Get`, but is case-independent. For example, `get`, `Get`, `gEt` and `GET` are all valid names for the PropertyGet function.

The PropertyGet function must be result returning. For a Simple Property, it may be monadic or niladic. For a Numbered or Keyed Property it must be monadic.

The result `R` may be any array. However, for a Keyed Property, `R` must conform to the rank and shape specified by `ipa.Indexers` or be scalar.

If monadic, `ipa` is an instance of the internal class .

In all cases, `ipa.Name` contains the name of the Property being referenced and `NewValue` is undefined (`VALUE ERROR`).

If the Property is *Simple*, `ipa.Indexers` is undefined (`VALUE ERROR`).

If the Property is *Numbered*, `ipa.Indexers` is an integer vector of the same length as the rank of the property (as implied by the result of the `Shape` function) that identifies a single element of the Property whose value is to be obtained. In this case, `R` must be scalar.

If the Property is *Keyed*, `ipa.IndexersSpecified` is a Boolean vector with the same length as the rank of the property (as implied by the result of the `Shape` function). A value of 1 means that an indexing array for the corresponding dimension of the Property was specified, while a value of 0 means that the corresponding dimension was elided. `ipa.Indexers` is a vector of the same length containing the arrays that were specified within the square brackets in the reference expression. Specifically, `ipa.Indexers` will contain one fewer elements than, the number of semi-colon (;) separators. If any index was elided, the corresponding element of `ipa.Indexers` is `NULL`.

Note:

- It is not possible to predict the number of times that a PropertyGet, PropertySet or PropertyShape function will be called by a particular APL expression, as this depends upon how that expression is implemented internally. You should therefore not rely on the number of times that a Get, Set or Shape function is called, and none should have any side effects on any other APL object

PropertySet Function

Set ipa

The name of the PropertySet function must be **Set**, but is case-independent. For example, **set**, **Set**, **sEt** and **SEt** are all valid names for the PropertySet function.

The PropertySet function must be monadic and may not return a result.

ipa is an instance of the internal class .

In all cases, **ipa.Name** contains the name of the Property being referenced and **NewValue** contains the new value(s) for the element(s) of the Property being assigned.

If the Property is *Simple*, **ipa.Indexers** is undefined (**VALUE ERROR**).

If the Property is *Numbered*, **ipa.Indexers** is an integer vector of the same length as the rank of the property (as implied by the result of the **Shape** function) that identifies a single element of the Property whose value is to be set.

If the Property is *Keyed*, **ipa.IndexersSpecified** is a Boolean vector with the same length as the rank of the property (as implied by the result of the **Shape** function). A value of 1 means that an indexing array for the corresponding dimension of the Property was specified, while a value of 0 means that the corresponding dimension was elided. **ipa.Indexers** is a vector containing the arrays that were specified within the square brackets in the assignment expression. Specifically, **ipa.Indexers** will contain one fewer elements than, the number of semi-colon (;) separators. If any index was elided, the corresponding element of **ipa.Indexers** is **NULL**. However, if the Keyed Property is being assigned in its entirety, without square-bracket indexing, **ipa.Indexers** is undefined (**VALUE ERROR**).

Note:

- It is not possible to predict the number of times that a PropertyGet, PropertySet or PropertyShape function will be called by a particular APL expression, as this depends upon how that expression is implemented internally. You should therefore not rely on the number of times that a Get, Set or Shape function is called, and none should have any side effects on any other APL object

PropertyShape Function

$R \leftarrow \text{Shape } \{ipa\}$

The name of the PropertyShape function must be `Shape`, but is case-independent. For example, `shape`, `Shape`, `sHape` and `SHAPE` are all valid names for the PropertyShape function.

A PropertyShape function is only called if the Property is a Numbered Property.

The PropertyShape function must be niladic or monadic and must return a result.

If monadic, `ipa` is an instance of the internal class `.ipa.Name` contains the name of the Property being referenced and `NewValue` and `Indexers` are undefined (`VALUE ERROR`).

The result `R` must be an integer vector or scalar that specifies the `rank` of the Property. Each element of `R` specifies the length of the corresponding dimension of the Property. Otherwise, the reference or assignment to the Property will fail with `DOMAIN ERROR`.

Note that the result `R` is used by APL to check that the number of indices corresponds to the rank of the Property and that the indices are within the bounds of its dimensions. If not, the reference or assignment to the Property will fail with `RANK ERROR` or `LENGTH ERROR`.

Note:

- It is not possible to predict the number of times that a PropertyGet, PropertySet or PropertyShape function will be called by a particular APL expression, as this depends upon how that expression is implemented internally. You should therefore not rely on the number of times that a Get, Set or Shape function is called, and none should have any side effects on any other APL object

Chapter 4:

APL Files

Introduction

Most languages store programs and data separately. APL is unusual in that it allows you to store programs and data together in a workspace.

This can be inefficient if your dataset gets very large; when your workspace is loaded, you are loading ALL of your data, whether you need it or not.

It also makes it difficult for other users to access your data, particularly if you want them to be able to update it.

In these circumstances, you must extract your data from your workspace, and write it to a file on disk, thus separating your data from your program. There are many different kinds of file format. This section is concerned with the APL Component File system which preserves the idea that your data consists of APL objects; hence you can only access this type of file from within APL

The Component File system has a set of system functions through which you access the file. Although this means that you have to learn a whole new set of functions in order to use files, you will find that they provide you with a very powerful mechanism to control access to your data.

Component Files

Overview

A **component file** is a data file maintained by Dyalog APL. It contains a series of APL arrays known as **components** which are accessed by reference to their relative position or **component number** within the file. Component files are just like other data files and there are no special restrictions imposed on names or sizes.

A set of system functions is supplied to perform a range of file operations. These provide facilities to create or delete files, and to read and write components. Facilities are also provided for multi-user access, including the capability to determine who may do what, and file locking for concurrent updates.

Tying and Untying Files

To access an existing component file it must be **typed**, i.e. opened for use. The tie may be **exclusive** (single-user access) or **shared** (multi-user access). A file is **untied**, i.e. closed, using `⎕FUNTIE` or on terminating Dyalog APL. File ties survive `)LOAD`, `⎕LOAD` and `)CLEAR` operations.

Tie Numbers

A file is tied by associating a **file name** with a **tie number**. Tie numbers are integers in the range 1 - 2147483647 and, you can supply one explicitly, or have the interpreter allocate the next available one by specifying 0. The system functions which tie files return the tie number as a "shy" result.

Creating and Removing Files

A component file is created using `⎕FCREATE` which automatically ties the file for exclusive use. A newly created file is empty, i.e. contains 0 components. A file is removed with `⎕FERASE`, although it must be exclusively tied to do so.

Adding and Removing Components

Components are added to a file using `⎕FAPPEND` and removed using `⎕FDROP`. Component numbers are allocated consecutively starting at 1. Thus a new component added by `⎕FAPPEND` is given a component number which is one greater than that of the last component in the file. Components may be removed from the beginning or end of the file, but not from the middle. Component numbers are therefore contiguous.

Reading and Writing Components

Components are read using `⊞FREAD` and overwritten using `⊞FREPLACE`. There are no restrictions on the size or type of array which may replace an existing component. Components are accessed by component number.

Component Information

In addition to the data held in a component, the user ID that wrote it and the time at which it was written is also recorded.

Multi-User Access

`⊞FSTIE` ties a file for **shared** (i.e. multi-user) access. This kind of access would be appropriate for a multi-user UNIX system, a network of single user PCs, or multiple APL tasks under Microsoft Windows.

`⊞FHOLD` provides the means for the user to temporarily prevent other co-operating users from accessing one or more files. This is necessary to allow a single logical update involving more than one component, and perhaps more than one file, to be completed without interference from another user. `⊞FHOLD` is applicable to External Variables as well as Component Files

File Access Control

There are two levels of file access control. As a regular file, the operating system read/write controls for owner and other users apply. In addition, Dyalog manages its own access controls using the **access matrix**. This is an integer matrix with 3 columns and any number of rows. Column 1 contains user numbers, column 2 an encoding of permitted file operations, and column 3 passnumbers. Each row specifies which file operations may be performed by which user(s) with which passnumber. A value of 0 in column 1 specifies all users. A value of `⍒1` in column 2 specifies all file operations. A value of 0 in column 3 specifies no passnumber. If any row of the access matrix contains `(0 ⍒1 0)` it specifies that all users may perform all file operations with no passnumber.

User Number

Under Windows, this is a number which is defined by the **apluid** parameter. If you intend to use Dyalog's **access matrix** to control file access in a multi-user environment, it is desirable to allocate to each user, a distinct **user number**. However, if you intend to rely on underlying operating system controls, allocating a user number of 0 (the default installation value) to everyone is more appropriate. Under non-Windows platforms the User Number is set to be the effective user-id of the APL process and cannot be altered. In both cases, a user number of 0 causes APL to circumvent the access matrix mechanism described below.

Permission Code

This is an integer representation of a Boolean mask. Each bit in the mask indicates whether or not a particular file operation is permitted as follows:

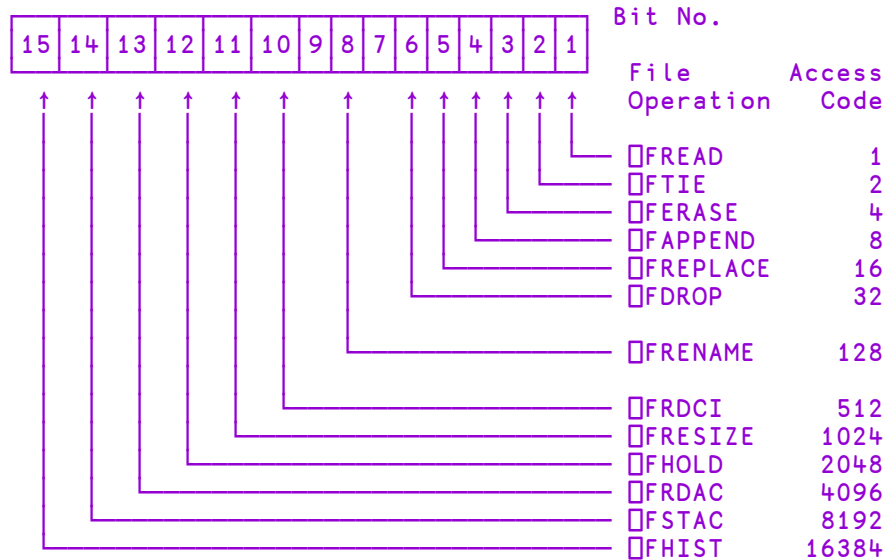

For example, if bits 1, 4 and 6 are set and all other relevant bits are zero only FREAD, FAPPEND and FDROP are permitted. A convenient way to set up the mask is to sum the access codes associated with each operation.

For example, the value 41 (1+8+32) authorises FREAD, FAPPEND and FDROP. A value of ~ 1 (all bits set) permits all operations. Thus by subtracting the access codes of operations to be forbidden, it is possible to permit all but certain types of access. For example, a value of ~ 133 ($\sim 1 - 4 + 128$) permits all operations except FERASE and FRENAME. Note that the value of unused bits is ignored. Any non-zero permission code allows FSTIE and FSIZE. FCREATE, FUNTIE, FLIB, FNAMES and FNUMS are not subject to access control. Passnumbers may also be used to establish different levels of access for the same user.

When the user attempts to tie a file using FTIE or FSTIE a row of the access matrix is selected to control this and subsequent operations.

If the user is the owner, and the owner's user ID does not appear in the access matrix, the value (AI[1] ~ 1 0) is conceptually appended to the access matrix. This ensures that the owner has full access rights unless they are explicitly restricted.

The chosen row is the first row in which the value in column 1 of the access matrix matches the user ID and the value in column 3 matches the supplied passnumber which is taken to be zero if omitted.

If there is no match of user ID and passnumber in the access matrix (including implicitly added rows) then no access is granted and the tie fails with a FILE ACCESS ERROR.

Once the applicable row of the access matrix is selected, it is used to verify all subsequent file operations. The passnumber used to tie the file MUST be used for every subsequent operation. Secondly, the appropriate bit in the permission code corresponding to the file operation in question must be set. If either of these conditions is broken, the operation will fail with FILE ACCESS ERROR.

If the access matrix is changed while a user has the file tied, the change takes immediate effect. When the user next attempts to access the file, the applicable row in the access matrix will be reselected subject to the supplied passnumber being the same as that used to tie the file. If access with that password is rescinded the operation will fail with FILE ACCESS ERROR.

When a file is created using `□FCREATE`, the access matrix is empty. At this stage, the owner has full access with passnumber 0, but no access with a non-zero passnumber. Other users have no access permissions. Thus only the owner may initialise the access matrix.

User 0

If a user has an `apluid` of 0, the access matrix and supplied passnumbers are ignored. This user is granted full and unrestricted access rights to all component files, subject only to underlying operating system restrictions.

General File Operations

`□FLIB` gives a list of **component files** in a given directory. `□FNAMES` and `□FNUMS` give a list of the names and tie numbers of tied files. These general operations which apply to more than one file are not subject to access controls.

Component File System Functions

See *Language Reference* for full details of the syntax of these system functions.

General	
<code>□FAVAIL</code>	Report file system availability
File Operations	
<code>□FCREATE</code>	Create a file
<code>□FTIE</code>	Tie an existing file (exclusive)
<code>□FSTIE</code>	Tie an existing file (shared)
<code>□FUNTIE</code>	Untie file(s)
<code>□FCOPY</code>	Copy a file
<code>□FERASE</code>	Erase a file
<code>□FRENAME</code>	Rename a file
File information	
<code>□FHIST</code>	Report file events
<code>□FNUMS</code>	Report tie numbers of tied files
<code>□FNAMES</code>	Report names of tied files
<code>□FLIB</code>	Report names of component files
<code>□FPROPS</code>	Report file properties
<code>□FSIZE</code>	Report size of file
Writing to the file	
<code>□FAPPEND</code>	Append a component to the file
<code>□FREPLACE</code>	Replace an existing component
Reading from a file	
<code>□FREAD</code>	Read one or more components
<code>□FRDCI</code>	Read component information

Manipulating a file	
<code>□FDROP</code>	Drop a block of components
<code>□FRESIZE</code>	Change file size (forces a compaction)
<code>□FCHK</code>	Check and repair a file
Access manipulation	
<code>□FSTAC</code>	Set file access matrix
<code>□FRDAC</code>	Read file access matrix
Control multi-user access	
<code>□FHOLD</code>	Hold file(s) - see later section for details

Using the Component File System

Let us suppose that you have written an APL system that builds a personnel database, containing the name, age and place of birth of each employee. Let us assume that you have created a variable `DATA`, which is a nested vector with each element containing a person's name, age and place of birth:

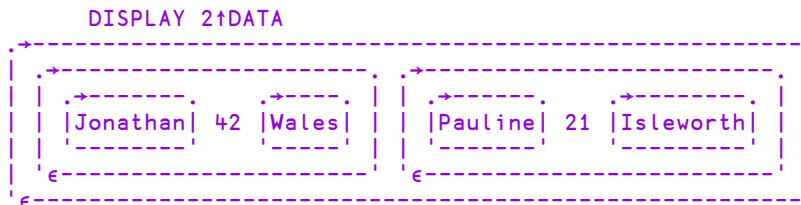

Then the following APL expressions can be used to access the database:

Example 1:

Show record 2

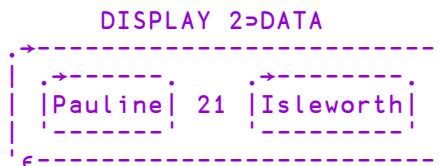

Example 2:

How many people in the database?

`123 ρDATA`

Example 3:

Update Pauline's age

```
(2 2>DATA)←16
```

Example 4:

Add a new record to the database

```
DATA ,← c'Maurice' 18 'London'
```

Now let's build a component file to hold our personnel database.

Create a new file, giving the file name, and the number you wish to use to identify it (the file tie number):

```
'COMPFILE' □FCREATE 1
```

If the file already exists, or you have already used this tie number, then APL will respond with the appropriate error message.

Now write the data to the file. We could write a function that loops to do this, but it is neater to take advantage of the fact that our data is a nested vector, and use each (∘).

```
DATA □FAPPEND∘ 1
```

Now we'll try our previous examples using this file.

Example 1:

Show record 2

```
DISPLAY □FREAD 1 2
```

```
┌──────────┬──────────┬──────────┐
│ Pauline  │ 21      │ Isleworth │
└──────────┴──────────┴──────────┘
```

Example 2:

How many people in our database?

```
□FSIZE 1      A First component, next  
1 125 10324 4294967295 A component, file size,  
                      A maximum file size
```

```
~1+2>□FSIZE 1  A Number of data items
```

The fourth element of `□FSIZE` indicates the file size limit. Dyalog APL does not impose a file size limit, although your operating system may do so, but the concept is retained in order to make this version of Component Files compatible with others.

Example 3:

Update Pauline's age

```
REC ← ⎕FREAD 1 2      Ⓜ Read second component
REC[2] ← 18           Ⓜ Change age
REC ⎕FREPLACE 1 2    Ⓜ And replace component
```

Example 4:

Add a new record

```
('Janet' 25 'Basingstoke') ⎕FAPPEND 1
```

Example 5:

Rename our file

```
'PERSONNEL' ⎕FRENAME 1
```

Example 6:

Tie an existing file; give file name and have the interpreter allocate the next available tie number.

```
'SALARIES' ⎕FTIE 0
2
```

Example 7:

Give everyone access to the PERSONNEL file

```
(1 3p0 ~1 0)⎕FSTAC 1
```

Example 8:

Set different permissions on SALARIES.

```
AM ← 1 3p1 ~1 0      Ⓜ Owner ID 1 has full access
AM;← 102 1 0         Ⓜ User ID 102 has READ only
AM;← 210 2073 0     Ⓜ User ID 210 has
                    Ⓜ READ+APPEND+REPLACE+HOLD
AM ⎕FSTAC 2         Ⓜ Store access matrix
```

Example 9:

Report on file names and associated numbers

```
⎕FNAMES,⎕FNUMS
PERSONNEL 1
SALARIES 2
```

Example 10:

Untie all files

```
⊞FUNTIE ⊞FNUMS
```

Programming Techniques

Controlling Multi-User Access

Obviously, Dyalog APL contains mechanisms that prevent data getting mixed up if two users update a file at the same time. However, it is the programmer's responsibility to control the logic of multi-user updates.

For example, suppose two people are updating our database at the same time. The first checks to see if there is an entry for 'Geoff', sees that there isn't so adds a new record. Meanwhile, the second user is checking for the same thing, and so also adds a record for 'Geoff'. Each user would be running code similar to that shown below:

```

▽ UPDATE;DATA;NAMES
[1]  ⍺ Using the component file
[2]  'PERSONNEL' ⊞FSTIE 1
[3]  NAMES←→⊞FREAD ⋆ 1,⋆1+2⇒⊞FSIZE 1
[4]  →END×1(←'Geoff')∈NAMES
[5]  ('Geoff' 41 'Hounslow')⊞FAPPEND 1
[6]  END:⊞FUNTIE 1
▽

```

The system function `⊞FHOLD` provides the means for the user to temporarily prevent other co-operating users from accessing one or more files. This is necessary to allow a single logical update, perhaps involving more than one record or more than one file, to be completed without interference from another user.

The code above is replaced by that below:

```

      ▽ UPDATE;DATA;NAMES
[1]  A Using the component file
[2]  'PERSONNEL' □FSTIE 1
[3]  □FHOLD 1
[4]  NAMES←→□FREAD `` 1,``ι-1+2□FSIZE 1
[5]  →END×ι(c'Geoff')∈NAMES
[6]  ('Geoff' 41 'Hounslow')□FAPPEND 1
[7]  END:□FUNTIE 1 ♦ □FHOLD ι0
      ▽

```

Successive □FHOLDS on a file executed by different users are queued by Dyalog APL; once the first □FHOLD is released, the next on the queue holds the file.

□FHOLDS are released by return to immediate execution, by □FHOLD ϑ, or by erasing the external variable.

It is easy to misunderstand the effect of □FHOLD. It is NOT a file locking mechanism that prevents other users from accessing the file. It only works if the tasks that wish to access the file co-operate by queuing for access by issuing □FHOLDS. It would be very inefficient to issue a □FHOLD on a file then allow the user to interactively edit the data with the hold in operation. What happens if he goes to lunch? Any other user who wants to access the file and cooperates by issuing a □FHOLD would have to wait in the queue for 3 hours until the first user returns, finishes his update and his □FHOLD is released. It is usually more efficient (as well as more friendly) to issue □FHOLDS around a small piece of critical code.

Suppose we had a control file associated with our personnel data base. This control file could be an external variable, or a component file. In both cases, the concept is the same; only the commands needed to access the file are different. In this example, we will use a component file:

```

      'CONTROL'□FCREATE 1      A Create control file
      (1 3ρ0 -1 0) □FSTAC 1  A Allow everyone access
      ϑ □FAPPEND 1           A Set component 1 to empty
      □FUNTIE 1             A And untie it

```

Now we'll allow our man that likes long lunch breaks to edit the file, but will control the hold in a more efficient way:

```

▽ EDIT;CMP;CV
[1]  A Share-tie the control file
[2]  'CONTROL' □FSTIE 1
[3]  A Share-tie the data file
[4]  'PERSONNEL' □FSTIE 2
[5]  A Find out which component the user wants to edit
[6]  ASK:CMP←ASKΔWHICHΔRECORD
[7]  A Hold the control file
[8]  □FHOLD 1
[9]  A Read the control vector
[10] CV←□FREAD 1 1
[11] A Make control vector as big as the data file
[12] CV←(-1+2÷□FSIZE 2)↑CV
[13] A Look at flag for this component
[14] →(FREE,INUSE)[1+CMP>CV]
[15] A In use - tell user and release hold
[16] INUSE:'Record in use' ♦ □FHOLD 0 ♦ →ASK
[17] A Ok to use - flag in-use and release hold
[18] FREE:CV[CMP]←1 ♦ CV □FREPLACE 1 1♦ □FHOLD 0
[19] A Let user edit the record
[20] EDITΔRECORD RECORD
[21] A When he's finished, clear the control vector
[22] □FHOLD 1
[23] CV←□FREAD 1 1 ♦CV[CMP]←0 ♦ CV □FREPLACE 1 1
[26] □FHOLD 0
[27] A And repeat
[28] →ASK
▽

```

Component 1 of our CONTROL file acts as a control vector. Its length is set equal to the number of components in the PERSONNEL file, and an element is set to 1 if a user wishes to access the corresponding data component. Only the control file is ever subject to a □FHOLD, and then only for a split-second, with no user inter-action being performed whilst the hold is active.

When the first user runs the function, the relevant entry in the control vector will be set to 1. If a second user accesses the database at the same time, he will have to wait briefly whilst the control vector is updated. If he wants the same component as the first user, he will be told that it is in use, and will be given the opportunity to edit something else.

This simple mechanism allows us to lock the components of our file, rather than the entire file. You can set up more informative control vectors than the one above; for example, you could easily put the user name into the control vector and this would enable you to tell the next user who is editing the component he is interested in.

File Design

Our personnel database could be termed a *record oriented* system. All the information relating to one person is easily obtained, and information relating to a new person is easily added, but if we wish to find the oldest person, we have to read ALL the records in the file.

It is sometimes more useful to have separate components, perhaps stored on separate files, that hold indexes of the data fields that you may wish to search on. For example, suppose we know that we always want to access our personnel database by name. Then it would make sense to hold an index component of names:

```

A Extract name field from each data record
'PERSONNEL' □FSTIE 1
NAMES←→□FREAD"1,"ι-1+2□FSIZE 2

A Create index file, and append NAMES
'INDEX' □FCREATE 2
NAMES □FAPPEND 2

```

Then if we want to find Pauline's data record:

```

NAMES←□FREAD 2,1      A Read index of names
CMP←NAMESι<'Pauline'  A Search for Pauline
DATA←□FREAD 1,CMP     A Read relevant record

```

There are many different ways to structure data files; you must design a structure that is the most efficient for your application.

Internal Structure

If you are going to make a lot of use of APL files in your systems, it is useful for you to have a rough idea of how Dyalog APL organises and manages the disk area used by such files.

The internal structure of external variables and component files is the same, and the examples given below apply to both.

Consider a component file with 3 components:

```

'TEMP' □FCREATE 1
'One' 'Two' 'Three' □FAPPEND"1

```

Dyalog APL will write these components onto contiguous areas of disk:

```

|1| |2| |3|
-----
| One | Two | Three |
-----

```

Replace the second component with something the same size:

```
'Six' □FREPLACE 1 2
```

This will fit into the area currently used by component 2.

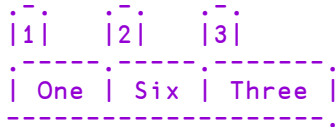

If your system uses fixed length records, then the size of your components never change, and the internal structure of the file remains static.

However, suppose we start replacing larger data objects:

```
'Bigger One' □FREPLACE 1 1
```

This will not fit into the area currently assigned to component 1, so it is appended to the end of the file. Dyalog APL maintains internal tables which contain the location of each component; hence, even though the components may not be physically stored in order, they can always be accessed in order.

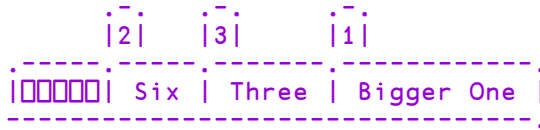

The area that was occupied by component 1 now becomes free.

Now we'll replace component 3 with something bigger:

```
'BigThree' □FREPLACE 1 3
```

Component 3 is appended to the end of the file, and the area that was used before becomes free:

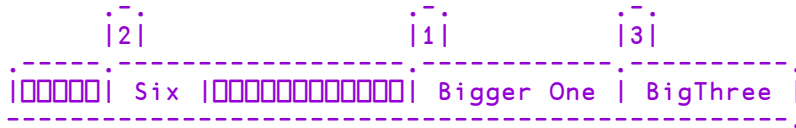

Dyalog APL keeps tables of the size and location of the free areas, as well as the actual location of your data. Now we'll replace component 2 with something bigger:

```
'BigTwo' □FREPLACE 1 2
```

Free areas are used whenever possible, and contiguous holes are amalgamated.

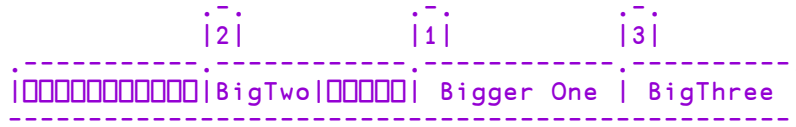

You can see that if you are continually updating your file with larger data objects, then the file structure can become fragmented. At any one time, the disk area occupied by your file will be greater than the area necessary to hold your data. However, free areas are constantly being reused, so that the amount of unused space in the file will seldom exceed 30%.

Whenever you issue a monadic `⊞RESIZE` command on a component file, Dyalog APL COMPACTS the file; that is, it restructures it by reordering the components and by amalgamating the free areas at the end of the file. It then truncates the file and releases the disk space back to the operating system (note that some versions of UNIX do not allow the space to be released). For a large file with many components, this process may take a significant time.

Error Conditions

FILE SYSTEM NOT AVAILABLE

A **FILE SYSTEM NOT AVAILABLE** (Error code 28) error will be generated if the operating system returns an unexpected error when attempting to get a lock on a component file. In Windows environments this may indicate that *opportunistic locks* (aka *oplocks*) are in use; they should be disabled if Dyalog components files are being used.

FILE SYSTEM TIES USED UP

A **FILE SYSTEM TIES USED UP** (Error code 30) error will be generated when an attempt is made to open more component files than is possible.

FILE TIED

A **FILE TIED** error is reported if you attempt to tie a file which another user has exclusively tied.

Limitations

File Tie Quota

The File Tie Quota is the maximum number of files that a user may tie concurrently. Dyalog APL itself allows a maximum of 1024 under UNIX and 512 under Windows, although in either case your installation may impose a lower limit. When an attempt is made to exceed this limit, the report **FILE TIE QUOTA** (Error code 31) is given. This error will also be generated if an attempt is made to exceed the maximum number of open files that is imposed by the operating system.

File Name Quota

Dyalog APL records the names of each user's tied files in a buffer of 40960 bytes. When this buffer is full, the report **FILE NAME QUOTA USED UP** (Error code 32) will be given. This is only likely to occur if long pathnames are used to identify files.

The Effect of Buffering

Disk drives are fairly slow devices, so most operating systems take advantage of a facility called buffering. This is shown in simple terms below:

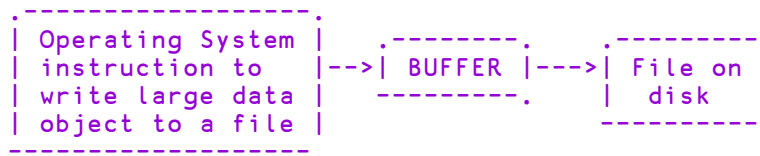

When you issue a write to a disk area, the data is not necessarily sent straight to the disk. Sometimes it is written to an internal buffer (or cache), which is usually held in (fast) main memory. When the buffer is full, the contents are passed to the disk. This means that at any one time, you could have data in the buffer, as well as on the disk. If your machine goes down whilst in this state, you could have a partially updated file on the disk. In these circumstances, the operating system generally recovers your file automatically.

If this facility is exploited, it offers very fast file updating. For systems that are I/O bound, this is a very important consideration. However, the disadvantage is that whilst it may appear that a write operation has completed successfully, part of the data may still be residing in the buffer, waiting to be flushed out to the disk. It is usually possible to force the buffer to empty; see your operating system manuals for details (UNIX automatically invokes the `sync ()` command every few seconds to flush its internal buffers).

Dyalog APL exploits this facility, employing buffers internal to APL as well as making use of the system buffers. Of course, these techniques cannot be used when the file is shared with other users; obviously, the updates must be written immediately to the disk. However, if the file is exclusively tied, then several layers of buffers are employed to ensure that file access is as fast as possible.

You can ensure that the contents of all internal buffers are flushed to disk by issuing `⎕FUNTIE Ⓞ` at any time.

Integrity and Security

The structure of component files, the asynchronous nature of the buffering performed by APL, by the Operating System, and by the external device sub-system, introduces the potential danger that a component file might become damaged. To prevent this happening, the component file system includes optional journaling and check-sum features. These are optional because the additional security these features provide comes at the cost of reduced performance. You can choose the level of security that is appropriate for your application.

When journaling is enabled (see `⎕FPROPS`), files are updated using a journal which effectively prevents system or network failures from causing file damage.

Additional security is provided by the check sum facility which enables component files to be repaired using the system function `⎕FCHK`. See *Language Reference Guide: File Check and Repair*.

Level 1 journaling protects a component file from damage caused by an abnormal termination of the APL process. This could occur if the process is deliberately or accidentally terminated by the user or by the Operating System, or by an error in Dyalog APL.

Level 2 journaling provides protection not just against the possibility that the APL process terminates abnormally, but that the Operating System itself fails. However, a damaged component file must be explicitly repaired using the system function `⎕FCHK` which will repair any damaged components by rolling them back to their previous states.

Level 3 provides the same level of protection as Level 2, but following the abnormal termination of either APL or the Operating System, the rollback of an incomplete update will be automatic and no explicit repair will be needed.

Higher levels of Journaling inevitably reduce the performance of component file updates.

For further information, see [□FPROPS](#) and [□FCHK](#).

Operating System Commands

APL files are treated as normal data files by the operating system, and may be manipulated by any of the standard operating system commands.

Do not use operating system commands to copy, erase or move component files that are tied and in use by an APL session.

Chapter 5:

Error Trapping

Standard Error Action

The standard system action in the event of an error or interrupt whilst executing an expression is to suspend execution and display an error report. If necessary, the state indicator is cut back to a statement such that there is no halted locked function visible in the state indicator.

The error report consists of up to three lines

1. The error message, preceded by the symbol $\$$ if the error occurred while evaluating the Execute function.
2. The statement in which the error occurred (or expression being evaluated by the Execute function), preceded by the name of the function and line number where execution is suspended unless the state indicator has been cut back to immediate execution mode. If the state indicator has been cut back because of a locked function in execution, the displayed statement is that from which the locked function was invoked.
3. The symbol \wedge under the last referenced symbol or name when the error occurred. All code to the right of the \wedge symbol in the expression will have been evaluated.

Examples

```

      X PLUS U
VALUE ERROR
      X PLUS U
          ^

      FOO
INDEX ERROR
FOO[2] X+X+A[I]
          ^

      CALC
$DOMAIN ERROR
CALC[5] ÷0
          ^

```

Error Trapping Concepts

The purpose of this section is to show some of the ways in which the ideas of error trapping can be used to great effect to change the flow of control in a system.

First, we must have an idea of what is meant by error trapping. We are all used to entering some duff APL code, and seeing a (sometimes) rather obscure, esoteric error message echoed back:

```
10÷0
DOMAIN ERROR
10÷0
^
```

This message is ideal for the APL programmer, but not so for the end user. We need a way to bypass the default action of APL, so that we can take an action of our own, thereby offering the end user a more meaningful message.

Every error message reported by Dyalog APL has a corresponding error number (for a list of error codes and message, see [⎕TRAP](#), Language Reference). Many of these error numbers plus messages are common across all versions of APL. We can see that the code for **DOMAIN ERROR** is 11, whilst **LENGTH ERROR** has code 5.

Dyalog APL provides two distinct but related mechanisms for the trapping and control of errors. The first is based on the control structure `:Trap ... :EndTrap`, and the second, on the system variable `⎕TRAP`. The control structure is easier to administer and so is recommended for normal use, while the system variable provides slightly finer control and may be necessary for specialist applications.

Last Error number and Diagnostic Message

Dyalog APL keeps a note of the last error that occurred, and provides this information through system functions: `⎕EN`, `⎕EM` and `⎕DM`.

```

      10÷0
DOMAIN ERROR
      10÷0
      ^

```

Error Number for last occurring error:

```

      ⎕EN
11

```

Error Message associated with code 11:

```

      ⎕EM 11
DOMAIN ERROR

```

`⎕DM` (Diagnostic Message) is a 3 element nested vector containing error message, expression and caret:

```

      ⎕DM
DOMAIN ERROR      10÷0      ^

```

Use function `DISPLAY` to show structure:

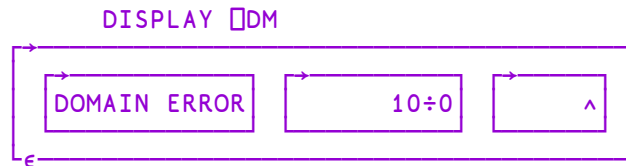

Mix (`↑`) of this vector produces a matrix that displays the same as the error message produced by APL:

```

      ↑⎕DM
DOMAIN ERROR
      10÷0
      ^

```

Error Trapping Control Structure

You can embed a number of lines of code in a `:Trap` control structure within a defined function.

```
[1]   ...
[2]   :Trap 0
[3]       ...
[4]       ...
[5]   :EndTrap
[6]   ...
```

Now, whenever *any* error occurs in one of the enclosed lines, or in a function called from one of the lines, processing stops immediately and control is transferred to the line following the `:EndTrap`. The 0 argument to `:Trap`, in this case represents any error. To trap only specific errors, you could use a vector of error numbers:

```
[2]   :Trap 11 2 3
```

Notice that in this case, no extra lines are executed after an error. Control is passed to line [6] either when an error has occurred, *or* if all the lines have been executed without error. If you want to execute some code *only* after an error, you could re-code the example like this:

```
[1]   ...
[2]   :Trap 0
[3]       ...
[4]       ...
[5]   :Else
[6]       ...
[7]       ...
[8]   :EndTrap
[9]   ...
```

Now, if an error occurs in lines [3-4], (or in a function called from those lines), control will be passed immediately to the line following the `:Else` statement. On the other hand, if all the lines between `:Trap` and `:Else` complete successfully, control will pass out of the control structure to (in this case) line [9].

The final refinement is that specific error cases can be accommodated using `:Case [List]` constructs in the same manner as the `:Select` control structure.

```
[1]   :Trap 17+!21           A Component file errors.
[2]       tie←name []ftie 0   A Try to tie file
[3]       'OK'
[4]   :Case 22
[5]       'Can''t find ',name
[6]   :CaseList 25+!13
[7]       'Resource Problem'
[8]   :Else
[9]       'Unexpected Problem'
[10]  :EndTrap
```

Note that `:Trap` can be used in conjunction with `[]SIGNAL` described below.

Traps can be nested. In the following example, code in the inner trap structure attempts to tie a component file, and if unsuccessful, tries to create one. In either case, the tie number is then passed to function `ProcessFile`. If an error other than 22 (`FILE NAME ERROR`) occurs in the inner trap structure, or an error occurs in function `ProcessFile` (or any of its called function), control passes to line immediately to line [9].

```
[1]   :Trap 0
[2]       :Trap 22
[3]           tie←name []ftie 0
[4]       :Else
[5]           tie←name []fcreate 0
[6]       :EndTrap
[7]       ProcessFile tie
[8]   :Else
[9]       'Unexpected Error'
[10]  :EndTrap
```

Trap System Variable: `⌈TRAP`

The second way of trapping errors is to use the system variable: `⌈TRAP`.

`⌈TRAP`, can be assigned a nested vector of **trap specifications**. Each trap specification is itself a nested vector, of length 3, with each element defined as:

list of error numbers	The error numbers we are interested in.
action code	Either 'E' (Execute) or 'C' (Cut Back). There are others, but they are seldom used.
action to be taken	APL expression, usually a branch statement or a call to an APL function.

So a single trap specification may be set up as:

```
⌈TRAP←5 'E' 'ACTION1'
```

and a multiple trap specification as:

```
⌈TRAP←(5 'E' 'ACTION1')((1 2 3) 'C' 'ACTION2')
```

The action code **E** tells APL that you want your action to be taken in the function in which the error occurred, whereas the code **C** indicates that you want your action to be taken in the function where the `⌈TRAP` was *localised*. If necessary, APL must first travel back up the state indicator (cut-back) until it reaches that function.

Example Traps

Dividing by Zero

Let's try setting a `⌈TRAP` on **DOMAIN ERROR**:

```
MSG←''Please give a non-zero right arg''
⌈TRAP←11 'E' MSG
```

When we enter:

```
10÷0
```

APL executes the expression, and notes that it causes an error number 11. Before issuing the standard error, it scans its `⌈TRAP` table, to see if you were interested enough in that error to set a trap; you were, so APL executes the action specified by you:

```
10÷0
Please give non-zero right arg
```

Let's reset our `□TRAP`:

```
□TRAP←0p□TRAP      A No traps now set
```

and write a defined function to take the place of the primitive function `÷`:

```
▽ R←A DIV B
[1] R←A÷B
[2] ▽
```

Then run it:

```
10 DIV 0
DOMAIN ERROR
DIV[1] R←A÷B
      ^
```

Let's edit our function, and include a localised `□TRAP`:

```
▽ R←A DIV B;□TRAP
[1] A Set the trap
[2] □TRAP←11 'E' '→ERR1'
[3] A Do the work; if it results in error 11,
[4] A execute the trap
[5] R←A÷B
[6] A All OK if we got to here, so exit
[7] →0
[8] A Will get here only if error 11 occurred
[9] ERR1:'Please give a non-zero right arg'
    ▽
```

Running the function with good and bad arguments has the desired effect:

```
10 DIV 2
5

10 DIV 0
Please give a non-zero right arg
```

`□TRAP` is a variable like any other, and since it is localised in `DIV`, it is only effective in `DIV` and any other functions that may be called by `DIV`. So

```
10÷0
DOMAIN ERROR
10÷0
^
```

still gives an error, since there is no trap set in the global environment.

Other Errors

What happens to our function if we run it with other duff arguments:

```

      1 2 3 DIV 4 5
LENGTH ERROR
DIV [4] R←A÷B
      ^

```

Here is an error that we have taken no account of.

Change **DIV** to take this new error into account:

```

▽ R←A DIV B;□TRAP
[1]  A Set the trap
[2]  □TRAP←(11 'E' '→ERR1')(5 'E' '→ERR2')
[3]  A Do the work; if it results in error 11,
[4]  A execute the trap
[5]  R←A ÷ B
[6]  A All OK if we got to here, so exit
[7]  →0
[8]  A Will get here only if error 11 occurred
[9]  ERR1:'Please give a non-zero right arg'↔0
[10] A Will get here only if error 5 occurred
[11] ERR2:'Arguments must be same length'
▽

)RESET

      1 2 3 DIV 4 5
Arguments must be the same length

```

But here's yet another problem that we didn't think of:

```

      (2 3ρ16) DIV (2 3 4ρ124)
RANK ERROR
DIV [4] R←A÷B
      ^

```

Global Traps

Often when we are writing a system, we can't think of everything that may go wrong ahead of time; so we need a way of catching "everything else that I may not have thought of". The error number used for "everything else" is zero:

```
)RESET
```

Set a global trap:

```
⌈TRAP ← 0 'E' 'Invalid arguments' ' '
```

And run the function:

```
(2 3⍲6) DIV (2 3 4⍲24)
Invalid arguments
```

In this case, when APL executed line 4 of our function `DIV`, it encountered an error number 4 (`RANK ERROR`). It searched the local trap table, found nothing relating to error 4, so searched further up the stack to see if the error was mentioned anywhere else. It found an entry with an associated Execute code, so executed the appropriate action `AT THE POINT THAT THE ERROR OCCURRED`. Let's see what's in the stack:

```
)SI
DIV[4]*
      ↑⌈DM
RANK ERROR
DIV[4] R←A÷B
      ^
```

So although our action has been taken, execution has stopped where it normally would after a `RANK ERROR`.

Dangers

We must be careful when we set global traps; let's call the non-existent function `BUG` whenever we get an unexpected error:

```
)RESET
⌈TRAP ← 0 'E' 'BUG'
(2 3⍲6) DIV (2 3 4⍲24)
```

Nothing happens, since APL traps a `RANK ERROR` on line 4 of `DIV`, so executes the trap statement, which causes a `VALUE ERROR`, which activates the trap action, which causes a `VALUE ERROR`, which etc. etc. If we had also chosen to trap on 1000 (`ALL INTERRUPTS`), then we'd be in trouble!

Let's define a function `BUG`:

```

▽ BUG
[1] A Called whenever there is an unexpected error
[2] '*** UNEXPECTED ERROR OCCURRED IN: ',>1↓SI
[3] '*** PLEASE CALL YOUR SYSTEM ADMINISTRATOR'
[4] '*** WORKSPACE SAVED AS BUG.',>1↓SI
[5] A Tidy up ... reset LX, untie files ... etc
[6] SAVE 'BUG.',>1↓SI
[7] '*** LOGGING YOU OFF THE SYSTEM'
[8] OFF
▽

```

Now, whenever we run our system and an unexpected error occurs, our `BUG` function will be called.

```

10 DIV 0
Please give non-zero right arg
(2 3ρ16) DIV (2 3 4ρ12)

*** UNEXPECTED ERROR OCCURRED IN: DIV
*** PLEASE CALL YOUR SYSTEM ADMINISTRATOR'
*** WORKSPACE SAVED AS BUG.DIV
*** LOGGING YOU OFF THE SYSTEM'

```

The system administrator can then load `BUG.DIV`, look at the SI stack, discover the problem, and fix it.

Looking out for Specific Problems

In many cases, you can of course achieve the same effect of a trap by using APL code to detect the problem before it happens. Consider the function `TIEΔFILE`, which checks to see if a file already exists before it tries to access it:

```

▽ R←TIEΔFILE FILE;FILES
[1] A Tie file FILE with next available tie number
[2] A
[3] A All files in my directory
[4] FILES←FLIB 'mydir'
[5] A Remove trailing blanks
[6] FILES←dbr"↓FILES
[7] A Required file in list?
[8] →ERR×1~(cFILE)εFILES
[9] A Tie file with next number
[10] FILE FTIE R←1+[/0, FNUMS
[11] A ... and exit
[12] →0
[13] A Error message
[14] ERR:R←'File does not exist'
▽

```

This function executes the same code whether the file name is right or wrong, and it could take a while to get all the file names in your directory. It would be neater, and more efficient to take action ONLY when the file name is wrong:

```

▽ R←TIEΔFILE FILE;□TRAP
[1] A Tie file FILE with next available tie number
[2] A
[3] A Set trap
[4]   □TRAP←22 'E' '→ERR'
[5] A Tie file with next number
[6]   FILE □FTIE R←1+[/0,□FNUMS
[7] A ... and exit if OK
[8]   →0
[9] A Error message
[10]  ERR:R←'File does not exist'

```

Cut-Back versus Execute

Let us consider the effect of using Cut-Back instead of Execute. Consider the system illustrated below, in which the function **REPORT** gives the user the option of 4 reports to be generated:

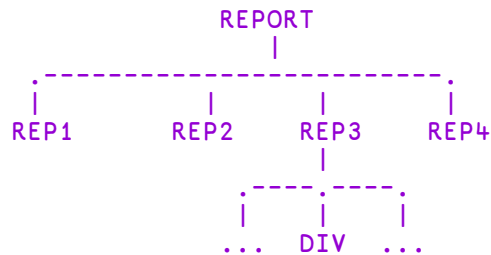

```

▽ REPORT;OPTIONS;OPTION;□TRAP
[1] A Driver functions for report sub-system. If an
[2] A unexpected error occurs, take action in the
[3] A function where the error occurred
[4] A
[5] A Set global trap
[6]   □TRAP←0 'E' 'BUG'
[7] A Available options
[8]   OPTIONS←'REP1' 'REP2' 'REP3' 'REP4'
[9] A Ask user to choose
[10] LOOP:→END×ι0=ρOPTION←MENU OPTIONS
[11] A Execute relevant function
[12]   ±OPTION
[13] A Repeat until EXIT
[14]   →LOOP
[15] A Now end
[16] END:

```

Suppose the user chooses **REP3**, and an unexpected error occurs in **DIV**. The good news is that the System Administrator gets a snapshot copy of the workspace that he can play about with:

```

        )LOAD BUG.DIV  A Load workspace
saved .....

        )SI           A Where did error occur?
DIV[4]*
REP3[6]
^
REPORT[7]

        ↑DM          A What happened?
RANK ERROR
DIV[4] R←A÷B
        ^
        ▽           A Edit function on top of stack
[0]R←A DIV B
.....

```

The bad news is, our user is locked out of the whole system, even though it may only be **REP3** that has a problem. We can get around this by making use of the CUT-BACK action code.

```

        ▽ REPORT;OPTIONS;OPTION;□TRAP
[1] A Driver functions for report sub-system. If an
[2] A unexpected error occurs, cut the stack back
[3] A to this function, then take action
[4] A
[5] A Set global trap
[6] □TRAP←0 'C' '→ERR'
[7] A Available options
[8] OPTIONS←'REP1' 'REP2' 'REP3' 'REP4'
[9] A Ask user to choose
[10] LOOP:→END×ι0=ρOPTION←MENU OPTIONS
[11] A Execute relevant function
[12] ^OPTION
[13] A Repeat until EXIT
[14] →LOOP
[15] A Tell user ...
[16] ERR:MESSAGE'Unexpected error in',OPTION
[17] A ... what's happening
[18] MESSAGE'Removing from list'
[19] A Remove option from list
[20] OPTIONS←OPTIONS~cOPTION
[21] A And repeat
[22] →LOOP
[23] A End
[24] END:

```

Suppose the user runs this version of `REPORT` and chooses `REP3`. When the unexpected error occurs in `DIV`, APL will check its trap specifications, and see that the relevant trap was set in `REPORT` with a cut-back code. APL therefore **cuts back the stack to the function in which the trap was localised, THEN takes the specified action**. Looking at the SI stack above, we can see that APL must jump out of `DIV`, then `REP3`, then `⚡`, to return to line 7 of `REPORT`; THEN it takes the specified action.

Signalling Events

It would be useful to be able to employ the idea of cutting back the stack and taking an alternative route through the code, when a condition other than an APL error occurs. To achieve this, we must be able to trap on errors other than APL errors, and we must be able to define these errors to APL. We do the former by using error codes in the range 500 to 999, and the latter by using `⌈SIGNAL`.

Consider our system; ideally, when an unexpected error occurs, we want to save a snapshot copy of our workspace (execute `BUG` in place), then immediately jump back to `REPORT` and reduce our options. We can achieve this by changing our functions a little, and using `⌈SIGNAL`:

```

▽ REPORT;OPTIONS;OPTION;⌈TRAP
[1] A Driver functions for report sub-system. If an
[2] A unexpected error occurs, make a snapshot copy
[3] A of the workspace, then cutback the stack to
[4] A this function, reduce the option list & resume
[5] A Set global trap
[6] ⌈TRAP←(500 'C' '→ERR')(0 'E' 'BUG')
[7] A Available options
[8] OPTIONS←'REP1' 'REP2' 'REP3' 'REP4'
[9] A Ask user to choose
[10] LOOP:→END×⚡0=ρOPTION←MENU OPTIONS
[11] A Execute relevant function
[12] ⚡OPTION
[13] A Repeat until EXIT
[14] →LOOP
[15] A Tell user ...
[16] ERR:MESSAGE'Unexpected error in',OPTION
[17] A ... what's happening
[18] MESSAGE'Removing from list'
[19] A Remove option from list
[20] OPTIONS←OPTIONS~<OPTION
[21] A And repeat
[22] →LOOP
[23] A End
[24] END:

```

```
▽ BUG
[1] A Called whenever there is an unexpected error
[2]   '*** UNEXPECTED ERROR OCCURRED IN: ',>1↓SI
[3]   '*** PLEASE CALL YOUR SYSTEM ADMINISTRATOR'
[4]   '*** WORKSPACE SAVED AS BUG.',>1↓SI
[5]   A Tidy up ... reset LX, untie files ... etc
[6]   SAVE 'BUG.',>1↓SI
[7]   '*** RETURNING TO DRIVER FOR RESELECTION'
[8]   SIGNAL 500
▽
```

Now when the unexpected error occurs, the first trap specification catches it, and the **BUG** function is executed in place. Instead of logging the user off as before, an **error 500** is signalled to APL. APL checks its trap specifications, sees that 500 has been set in **REPORT** as a cut-back, so cuts back to **REPORT** before branching to **ERR**.

Flow Control

Error handling, which employs a combination of all the system functions and variables described, allows us to dynamically alter the flow of control through our system, as well as allow us to handle errors gracefully. It is a very powerful facility, which is simple to use, but is often neglected.

Handling Unexpected Application Errors in Windows

When running an APL application, it is possible that an unexpected error will occur.

It is advisable to set a trap at the top level of the application which traps all possible errors; in this way the programmer can cater for any errors that are not already explicitly trapped by, for example, writing information to a file, or saving the workspace. On UNIX in particular it may also be useful to call `⎕OFF` with a positive integer to the right of the `⎕OFF` - this is used as the exit code to APL.

It is also possible to generate an error which it is not possible to trap in APL code; examples include attempting to access the session in a runtime APL, or generating an error which causes APL to crash (for example, by the incorrect use of a shared library function).

By default in such cases, APL will pop up a message box, and cannot continue until the user selects the OK button.

It is possible to override this behaviour by setting the configuration parameter `DYALOG_NOPOPUPS` to 1. This will cause system popups to be suppressed; it does not suppress application popups generated by APL code.

With `DYALOG_NOPOPUPS=1` APL will terminate silently, except that an `aplcore` file will be generated. The location of the `aplcore` file can be controlled by the configuration parameter `APLCoreName`. It may be more useful to ask the operating system to handle the unexpected termination of the APL process, for example, by bringing up a debugger, or Dr Watson. This can be achieved by setting the configuration parameter `PassExceptionsToOpSys` to 1. In most cases it is useful to set `DYALOG_NOPOPUPS=1` too.

It is also possible to log such events to the Windows Event Log. Setting the configuration parameter `DYALOG_EVENTLOGGINGLEVEL` to a value greater than 0 will cause this to happen. If the configuration parameter `DYALOG_EVENTLOGNAME` is not set, then an event log called `Dyalog` will be created which can be viewed from the Windows Event Viewer. The first time that such an event occurs the following entries will be added to the Windows registry:

The key *HKEY_LOCAL_MACHINE\SYSTEM\CurrentControlSet\Services\Eventlog\Dyalog APL* with values

Value Name	Value
Sources	Dyalog APL
MaxSize	150000000

The key *HKEY_LOCAL_MACHINE\SYSTEM\CurrentControlSet\Services\Eventlog\Dyalog APL\Dyalog APL* with values

Value Name	Value
EventMessageFile	DYALOG\dyalog.exe
CategoryMessageFile	DYALOG\dyalog.exe
Category Count	5
TypesSupported	7

where DYALOG is the directory where Dyalog APL is installed.

If **DYALOG_EVENTLOGNAME** is set, it should contain the name of the log to which events will be logged. For example

```
DYALOG_EVENTLOGNAME="MyApp Event Log"
```

When set, no registry entries are added by Dyalog, but if the above registry entries have been manually created, the events will be logged to an event log which has the name "MyApp Event Log". If the registry entries described above have not been created, the events will instead be logged into the Application Log, and the Event Viewer will display text similar to the following when events are viewed:

The description for Event ID (1) in Source (MyApp Event Log) cannot be found. The local computer may not have the necessary registry information or message DLL files to display messages from a remote computer. You may be able to use the /AUXSOURCE= flag to retrieve this description; see Help and Support for details. The following information is part of the event: Syserror: 995 code: 2 Aplcore "aplcore1" has been created.

Chapter 6:

Error Messages

Introduction

The error messages reported by APL are described in this section. Standard APL messages that provide information or report error conditions are summarised in [APL Error Messages on page 272](#) and described later in alphabetical order.

APL also reports messages originating from the Operating System (WINDOWS or UNIX) which are summarised in [Typical Operating System Error Messages on page 275](#) and [Windows Operating System Messages on page 277](#). Only those Operating System error messages that might occur through normal usage of APL operations are described here. Other messages could occur as a direct or indirect consequence of using the Operating System interface functions `□CMD` and `□SH` or system commands `)CMD` and `)SH`, or when a non-standard device is specified for the system functions `□ARBIN` or `□ARBOUT`. Refer to the WINDOWS or UNIX reference manual for further information about these messages.

Most errors may be trapped using the system variable `□TRAP`, thereby retaining control and inhibiting the standard system action and error report. The table, *Language Reference Guide: Trappable Event Codes* identifies the error code for trappable errors. The error code is also identified in the heading block for each error message when applicable.

See *Dyalog Programming Reference Guide* for a full description of the Error Handling facilities in Dyalog APL.

APL Errors

Table 1: APL Error Messages

	bad ws
	cannot create name
	clear ws
	copy incomplete
	defn error
	incorrect command
	insufficient resources
	is name
	Name already exists
	name is not a ws
	name saved date/time
	Namespace does not exist
	not copied name
	not found name
	not saved this ws is name
	sys error number
	too many names
	warning duplicate label
	warning duplicate name
	warning label name present in line 0
	warning pendent operation
	warning unmatched brackets
	warning unmatched parentheses
	was name
	ws not found
	ws too large

Error Code	Report
1	WS FULL
2	SYNTAX ERROR
3	INDEX ERROR
4	RANK ERROR
5	LENGTH ERROR
6	VALUE ERROR
7	FORMAT ERROR
10	LIMIT ERROR
11	DOMAIN ERROR
12	HOLD ERROR
16	NONCE ERROR
18	FILE TIE ERROR
19	FILE ACCESS ERROR
20	FILE INDEX ERROR
21	FILE FULL
22	FILE NAME ERROR
23	FILE DAMAGED
24	FILE TIED
25	FILE TIED REMOTELY
26	FILE SYSTEM ERROR
28	FILE SYSTEM NOT AVAILABLE
30	FILE SYSTEM TIES USED UP
31	FILE TIE QUOTA USED UP
32	FILE NAME QUOTA USED UP
34	FILE SYSTEM NO SPACE
35	FILE ACCESS ERROR - CONVERTING FILE
38	FILE COMPONENT DAMAGED

Error Code	Report
52	FIELD CONTENTS RANK ERROR
53	FIELD CONTENTS TOO MANY COLUMNS
54	FIELD POSITION ERROR
55	FIELD SIZE ERROR
56	FIELD CONTENTS/TYPE MISMATCH
57	FIELD TYPE/BEHAVIOUR UNRECOGNISED
58	FIELD ATTRIBUTES RANK ERROR
59	FIELD ATTRIBUTES LENGTH ERROR
60	FULL-SCREEN ERROR
61	KEY CODE UNRECOGNISED
62	KEY CODE RANK ERROR
63	KEY CODE TYPE ERROR
70	FORMAT FILE ACCESS ERROR
71	FORMAT FILE ERROR
72	NO PIPES
76	PROCESSOR TABLE FULL
84	TRAP ERROR
90	EXCEPTION
92	TRANSLATION ERROR
99	INTERNAL ERROR
1003	INTERRUPT
1005	EOF INTERRUPT
1006	TIMEOUT
1007	RESIZE
1008	DEADLOCK

Operating System Error Messages

[Table 2](#) refers to UNIX Operating Systems under which the error code reported by Dyalog APL is (100 + the UNIX file error number). The text for the error message, which is obtained by calling `pererror()`, will vary from one type of system to another.

[Table 3](#) refers to the equivalent error messages under Windows.

Table 2: Typical Operating System Error Messages

Error Code	Report
101	FILE ERROR 1 Not owner
102	FILE ERROR 2 No such file or directory
103	FILE ERROR 3 No such process
104	FILE ERROR 4 Interrupted system call
105	FILE ERROR 5 I/O error
106	FILE ERROR 6 No such device or address
107	FILE ERROR 7 Arg list too long
108	FILE ERROR 8 Exec format error
109	FILE ERROR 9 Bad file number
110	FILE ERROR 10 No children
111	FILE ERROR 11 No more processes
112	FILE ERROR 12 Not enough code
113	FILE ERROR 13 Permission denied
114	FILE ERROR 14 Bad address
115	FILE ERROR 15 Block device required
116	FILE ERROR 16 Mount device busy
117	FILE ERROR 17 File exists
118	FILE ERROR 18 Cross-device link
119	FILE ERROR 19 No such device

Error Code	Report
120	FILE ERROR 20 Not a directory
121	FILE ERROR 21 Is a directory
122	FILE ERROR 22 Invalid argument
123	FILE ERROR 23 File table overflow
124	FILE ERROR 24 Too many open files
125	FILE ERROR 25 Not a typewriter
126	FILE ERROR 26 Text file busy
127	FILE ERROR 27 File too large
128	FILE ERROR 28 No space left on device
129	FILE ERROR 29 Illegal seek
130	FILE ERROR 30 Read-only file system
131	FILE ERROR 31 Too many links
132	FILE ERROR 32 Broken pipe
133	FILE ERROR 33 Math argument
134	FILE ERROR 34 Result too large

Windows Operating System Error Messages

Table 3: Windows Operating System Messages

Error Code	Report
101	FILE ERROR 1 No such file or directory
102	FILE ERROR 2 No such file or directory
103	FILE ERROR 3 Exec format error
105	FILE ERROR 5 Not enough memory
106	FILE ERROR 6 Permission denied
107	FILE ERROR 7 Argument list too big
108	FILE ERROR 8 Exec format error
109	FILE ERROR 9 Bad file number
111	FILE ERROR 11 Too many open files
112	FILE ERROR 12 Not enough memory
113	FILE ERROR 13 Permission denied
114	FILE ERROR 14 Result too large
115	FILE ERROR 15 Resource deadlock would occur
117	FILE ERROR 17 File exists
118	FILE ERROR 18 Cross-device link
122	FILE ERROR 22 Invalid argument
123	FILE ERROR 23 File table overflow
124	FILE ERROR 24 Too many open files
133	FILE ERROR 33 Argument too large
134	FILE ERROR 34 Result too large
145	FILE ERROR 45 Resource deadlock would occur

APL Error Messages

There follows an alphabetical list of error messages reported from within Dyalog APL.

bad ws

This report is given when an attempt is made to `)COPY` or `)PCOPY` from a file that is not a valid workspace file. Invalid files include workspaces that were created by a version of Dyalog APL later than the version currently being used.

cannot create name

This report is given when an attempt is made to `)SAVE` a workspace with a name that is either the name of an existing, non-workspace file, or the name of a workspace that the user does not have permission to overwrite or create.

clear ws

This message is displayed when the system command `)CLEAR` is issued.

Example

```
)CLEAR  
clear ws
```

copy incomplete

This report is given when an attempted `)COPY` or `)PCOPY` fails to complete. Reasons include:

- Failure to identify the incoming file as a workspace.
- Not enough active workspace to accommodate the copy.

DEADLOCK

1008

If two threads succeed in acquiring a hold of two different tokens, and then each asks to hold the other token, they will both stop and wait for the other to release its token. The interpreter detects such cases and issues an error (1008) `DEADLOCK`.

defn error

This report is given when either:

- The system editor is invoked in order to edit a function that does not exist, or the named function is pendent or locked, or the given name is an object other than a function.
- The system editor is invoked to define a new function whose name is already active.
- The header line of a function is replaced or edited in definition mode with a line whose syntax is incompatible with that of a header line. The original header line is re-displayed by the system editor with the cursor placed at the end of the line. Back-spacing to the beginning of the line followed by line-feed restores the original header line.

Examples

```

      X←1
      ∇X
defn error

      ∇FOO[0]
[0]   R←FOO
[0]   R←FOO:X
defn error
[0]   R←FOO:X

      □LOCK 'FOO'
      ∇FOO[ ]
defn error
```

DOMAIN ERROR**11**

This report is given when either:

- An argument of a function is not of the correct type or its numeric value is outside the range of permitted values or its character value does not constitute valid name(s) in the context.
- An array operand of an operator is not an array, or it is not of the correct type, or its numeric value is outside the range of permitted values. A function operand of an operator is not one of a prescribed set of functions.
- A value assigned to a system variable is not of the correct type, or its numeric value is outside the range of permitted values
- The result produced by a function includes numeric elements which cannot be fully represented.

Examples

```

1÷0
DOMAIN ERROR
1÷0
^

```

```

(×◦'CAT')2 4 6
DOMAIN ERROR
(×◦'CAT')2 4 6
^

```

```

□IO←5
DOMAIN ERROR
□IO←5
^

```

EOF INTERRUPT**1005**

This report is given on encountering the end-of-file when reading input from a file. This condition could occur when an input to APL is from a file.

EXCEPTION**90**

This report is given when a Microsoft .NET object throws an exception. For details see *Language Reference Guide: Exception System Function*.

FIELD CONTENTS RANK ERROR 52

This report is given if a field content of rank greater than 2 is assigned to **□SM**.

FIELD CONTENTS TOO MANY COLUMNS 53

This report is given if the content of a numeric or date field assigned to **□SM** has more than one column.

FIELD POSITION ERROR 54

This report is given if the location of the field assigned to **□SM** is outside the screen.

FIELD CONTENTS TYPE MISMATCH 56

This report is given if the field contents assigned to **□SM** does not conform with the given field type e.g. character content with numeric type.

FIELD TYPE BEHAVIOUR UNRECOGNISED 57

This report is given if the field type or behaviour code assigned to **□SM** is invalid.

FIELD ATTRIBUTES RANK ERROR 58

This report is given if the current video attribute assigned to **□SM** is non-scalar but its rank does not match that of the field contents.

FIELD ATTRIBUTES LENGTH ERROR 59

This report is given if the current video attribute assigned to **□SM** is non-scalar but its dimensions do not match those of the field contents.

FULL SCREEN ERROR 60

This report is given if the required full screen capabilities are not available to **□SM**.
This report is only generated in UNIX environments.

KEY CODE UNRECOGNISED**61**

This report is given if a key code supplied to `□SR` or `□PFKEY` is not recognised as a valid code. It will also be generated if you attempt to generate a KeyPress event with an invalid Input Code.

KEY CODE RANK ERROR**62**

This report is given if a key code supplied to `□SR` or `□PFKEY` is not a scalar or a vector.

KEY CODE TYPE ERROR**63**

This report is given if a key code supplied to `□SR` or `□PFKEY` is numeric or nested; i.e. is not a valid key code.

FORMAT FILE ACCESS ERROR**70**

This report is given if the date format file to be used by `□SM` does not exist or cannot be accessed.

FORMAT FILE ERROR**71**

This report is given if the date format file to be used by `□SM` is ill-formed.

FILE ACCESS ERROR**19**

This report is given when the user attempts to execute a file system function for which the user is not authorised, or has supplied the wrong passnumber. It also occurs if the file specified as the argument to `□FERASE` or `□FRENAME` is not exclusively tied.

Examples

```

      'SALES' □FSTIE 1
      □FRDAC 1
0 4121 0
0 4137 99

      X □FREPLACE 1
FILE ACCESS ERROR
      X □FREPLACE 1
      ^

      'SALES' □FERASE 1
FILE ACCESS ERROR
      'SALES' □FERASE 1
      ^

```

FILE ACCESS ERROR CONVERTING

When a new version of Dyalog APL is used, it may be that improvements to the component file system demand that the internal structure of component files must alter. This alteration is performed by the interpreter on the first occasion that the file is accessed. If the operating system file permissions deny the ability to perform such a restructure, this report is given.

FILE COMPONENT DAMAGED**38**

This report is given if an attempt is made to access a component that is not a valid APL object. This will rarely occur, but may happen as a result of a previous computer system failure. Components files may be checked using `□FCHK`. See *Language Reference Guide: File Check and Repair*.

FILE DAMAGED**23**

This report is given if a component file becomes damaged. This rarely occurs but may result from a computer system failure. Components files may be checked using `□FCHK`. See *Language Reference Guide: File Check and Repair*.

FILE FULL**21**

This report is given if the file operation would cause the file to exceed its file size limit.

FILE INDEX ERROR**20**

This report is given when an attempt is made to reference a non-existent component.

Example

```

      □FSIZE 1
1 21 16578 4294967295

      □FREAD 1 34
FILE INDEX ERROR
      □FREAD 1 34
      ^
      □FDROP 1 50
FILE INDEX ERROR
      □FDROP 1 50
      ^

```

FILE NAME ERROR**22**

This report is given if:

- the user attempts to `□FCREATE` using the name of an existing file.
- the user attempts to `□FTIE` or `□FSTIE` a non-existent file, or a file that is not a component file.
- the user attempts to `□FERASE` a component file or `□NERASE` a native file with a name other than the EXACT name that was used when the file was tied.

FILE NAME QUOTA USED UP**32**

This report is given when the user attempts to execute a file system command that would result in the User's File Name Quota (see *Dyalog Programming Reference Guide: Component Files*) being exceeded.

This can occur with `□FCREATE`, `□FTIE`, `□FSTIE` or `□FRENAME`.

FILE SYSTEM ERROR**26**

This report is given if an input/output (I/O) error occurs when reading from or writing to the host file system. Contact your System Administrator.

If this occurs when the file is being written it may become damaged; it is therefore advisable to check the integrity of the file using `□FCHK` once the source of the I/O errors has been corrected. See *Language Reference Guide: File Check and Repair*.

FILE SYSTEM NO SPACE**34**

This report is given if the user attempts a file operation that cannot be completed because there is insufficient disk space.

FILE SYSTEM NOT AVAILABLE**28**

This error is generated if the operation system generates an unexpected error when attempting to get a lock on a component file. See *Dyalog Programming Reference Guide: Component Files* for details.

This error has been seen most frequently in Windows environments which have *opportunistic locks* (aka *oplocks*) enabled, either on the server that is running Dyalog APL, or on a server which has access to the same shared drives, or the disk array which contains the shared drives. In this scenario this error is not seen consistently, but rather is interspersed with other file-related errors. Oplocks should be disabled in environments where shared component files are used.

FILE SYSTEM TIES USED UP**30**

This error is generated when the maximum number of file ties for this APL instance has been reached. See *Dyalog Programming Reference Guide: Component Files* for details.

FILE TIE ERROR**18**

This report is given when the argument to a file system function contains a file tie number used as if it were tied when it is not or as if it were available when it is already tied. It also occurs if the argument to `□FHOLD` contains the names of non-existent external variables. It does not indicate that there is a problem with the underlying operating system's locking mechanism.

Examples

```

        □FNAMES, □FNUMS
SALES  1
COSTS  2
PROFIT 3

        X □FAPPEND 4
FILE TIE ERROR
        X □FAPPEND 4
        ^
        'NEWSALES' □FCREATE 2
FILE TIE ERROR
        'NEWSALES' □FCREATE 2
        ^

        'EXTVFILE' □XT 'BIGMAT'
        □FHOLD 'BIGMAT'
FILE TIE ERROR
        □FHOLD 'BIGMAT'
        ^
        □FHOLD= 'BIGMAT'

```

FILE TIED**24**

This report is given if the user attempts to tie a file that is exclusively tied by another task, or attempts to exclusively tie a file that is already share-tied by another task.

FILE TIED REMOTELY**25**

This report is given if the user attempts to tie a file that is exclusively tied by another task, or attempts to exclusively tie a file that is already share-tied by another task; and that task is running on other than the user's processor.

FILE TIE QUOTA USED UP**31**

This error is generated if an attempt is made to `□FTIE`, `□FSTIE` or `□FCREATE` a file when the user already has the maximum number of files tied. (See *Dyalog Programming Reference Guide:Component Files*)

FORMAT ERROR**7**

This report is given when the format specification in the left argument of system function `□FMT` is ill-formed.

Example

```
'A1,1X,I5'□FMT CODE NUMBER
FORMAT ERROR
'A1,1X,I5'□FMT CODE NUMBER
^
```

(The correct specification should be `'A1,X1,I5'`.)

HOLD ERROR**12**

This report is given when an attempt is made to save a workspace using the system function `□SAVE` if any external arrays or component files are currently held (as a result of a prior use of the system function `□FHOLD`).

Example

```
▽HOLD△SAVE
[1] □FHOLD 1
[2] □SAVE 'TEST'
▽

'FILE' □FSTIE 1

HOLD△SAVE
HOLD ERROR
HOLD△SAVE[2] □SAVE 'TEST'
^
```

incorrect command

This report is given when an unrecognised system command is entered.

Example

```
)CLERA
incorrect command
```

INDEX ERROR

3

This report is given when either:

- The value of an index, whilst being within comparison tolerance of an integer, is outside the range of values defined by the index vector along an axis of the array being indexed. The permitted range is dependent on the value of `IO`.
- The value specified for an axis, whilst being within comparison tolerance of an integer for a derived function requiring an integer axis value or a non-integer for a derived function requiring a non-integer, is outside the range of values compatible with the rank(s) of the array argument(s) of the derived function. Axis is dependent on the value of `IO`.

Examples

```
      A
1 2 3
4 5 6

INDEX A[1;4]
      ERROR
      A[1;4]
      ^

INDEX ↑ [2]'ABC' 'DEF'
      ERROR
      ↑ [2]'ABC' 'DEF'
      ^
```

INTERNAL ERROR**99**

INTERNAL ERROR indicates a severe system error from which Dyalog APL has recovered.

Should you encounter **INTERNAL ERROR**, Dyalog strongly recommends that you save your work(space), and report the issue.

INTERRUPT**1003**

This report is given when execution is suspended by entering a hard interrupt. A hard interrupt causes execution to suspend as soon as possible without leaving the environment in a damaged state.

Example

```
1 1 2 ⍋(2 100⍣200)∘.|?1000⍣200
```

(Hard interrupt)

INTERRUPT

```
1 1 2 ⍋(2 100⍣200)∘.|?1000⍣200
      ^
```

is name

This report is given in response to the system command **)WSID** when used without a parameter. **name** is the name of the active workspace including directory references given when loaded or named. If the workspace has not been named, the system reports **CLEAR WS**.

Example

```
)WSID
is WS/UTILITY
```

LENGTH ERROR**5**

This report is given when the shape of the arguments of a function do not conform, but the ranks do conform.

Example

```

      2 3+4 5 6
LENGTH ERROR
      2 3+4 5 6
      ^

```

LIMIT ERROR**10**

This report is given when a system limit is exceeded. System limits are installation dependent.

Example

```

      (16p1)p1
LIMIT ERROR
      (16p1)p1
      ^

```

NONCE ERROR**16**

This report is given when a system function or piece of syntax is not currently implemented but is reserved for future use.

NO PIPES**72**

This message applies to the UNIX environment ONLY.

This message is given when the limit on the number of pipes communicating between tasks is exceeded. An installation-set quota is assigned for each task. An associated task may require more than one pipe. The message occurs on attempting to exceed the account's quota when either:

- An APL session is started
- A non-APL task is started by the system function `□SH`
- An external variable is used.

It is necessary to release pipes by terminating sufficient tasks before proceeding with the required activity. In practice, the error is most likely to occur when using the system function `□SH`.

Examples

```
'via' □SH 'via'
NO PIPES
'via' □SH 'via'
^

'EXT/ARRAY' □XT 'EXVAR'
NO PIPES
'EXT/ARRAY' □XT 'EXVAR'
^
```

name is not a ws

This report is given when the name specified as the parameter of the system commands `)LOAD`, `)COPY` or `)PCOPY` is a reference to an existing file or directory that is not identified as a workspace.

This will also occur if an attempt is made to `)LOAD` a workspace that was `)SAVE`'d using a later version of Dyalog APL.

Example

```
)LOAD EXT\ARRAY
EXT\ARRAY is not a ws
```

Name already exists

This report is given when an `)NS` command is issued with a name which is already in use for a workspace object other than a namespace.

Namespace does not exist

This report is given when a `)CS` command is issued with a name which is not the name of a global namespace.

not copied name

This report is given for each object named or implied in the parameter list of the system command `)PCOPY` which was not copied because of an existing global referent to that name in the active workspace.

Example

```
)PCOPY WS/UTILITY A FOO Z
WS/UTILITY saved Mon Nov 1 13:11:19 1993
not copied Z
```

not found name

This report is given when either:

- An object named in the parameter list of the system command `)ERASE` is not erased because it was not found or it is not eligible to be erased.
- An object named in the parameter list (or implied list) of names to be copied from a saved workspace for the system commands `)COPY` or `)PCOPY` is not copied because it was not found in the saved workspace.

Examples

```
)ERASE []IO
not found []IO
```

```
)COPY WS/UTILITY UND
WS/UTILITY saved Mon Nov 1 13:11:19 1993
not found UND
```

not saved this ws is name

This report is given in the following situations:

- When the system command `)SAVE` is used without a name, and the workspace is not named. In this case the system reports `not saved this ws is CLEAR WS.`
- When the system command `)SAVE` is used with a name, and that name is not the current name of the workspace, but is the name of an existing file.

In neither case is the workspace renamed.

Examples

```

)CLEAR
)SAVE
not saved this ws is CLEAR WS

```

```

)WSID JOHND
)SAVE
)WSID ANDYS
)SAVE JOHND
not saved this ws is ANDYS

```

PROCESSOR TABLE FULL**76**

This report can only occur in a UNIX environment.

This report is given when the limit on the number of processes (tasks) that the computer system can support would be exceeded. The limit is installation dependent. The report is given when an attempt is made to initiate a further process, occurring when an APL session is started.

It is necessary to wait until active processes are completed before the required task may proceed. If the condition should occur frequently, the solution is to increase the limit on the number of processes for the computer system.

Example

```

'prefect' □SH 'prefect'
PROCESSOR TABLE FULL
'prefect' □SH 'prefect'
^

```

RANK ERROR**4**

This report is given when the rank of an argument or operand does not conform to the requirements of the function or operator, or the ranks of the arguments of a function do not conform.

Example

```

      2 3 + 2 2p10 11 12 13
RANK ERROR
      2 3 + 2 2p10 11 12 13
      ^

```

RESIZE**1007**

This report is given when the user resizes the **□SM** window. It is only applicable to Dyalog APL/X and Dyalog APL/W.

name saved date time

This report is given when a workspace is saved, loaded or copied.

date/time is the date and time at which the workspace was most recently saved.

Examples

```

      )LOAD WS/UTILITY
WS/UTILITY saved Fri Sep 11 10:34:35 1998

```

```

      )COPY SPACES GEOFF JOHND VINCE
./SPACES saved Wed Sep 30 16:12:56 1998

```

SYNTAX ERROR**2**

This report is given when a line of characters does not constitute a meaningful statement. This condition occurs when either:

- An illegal symbol is found in an expression.
- Brackets, parentheses or quotes in an expression are not matched.
- Parentheses in an expression are not matched.
- Quotes in an expression are not matched.
- A value is assigned to a function, label, constant or system constant.
- A strictly dyadic function (or derived function) is used monadically.
- A monadic function (or derived function) is used dyadically.
- A monadic or dyadic function (or derived function) is used without any arguments.
- The operand of an operator is not an array when an array is required.
- The operand of an operator is not a function (or derived function) when a function is required.
- The operand of an operator is a function (or derived function) with incorrect valency.
- A dyadic operator is used with only a single operand.
- An operator is used without any operands.

Examples

```
A>10)/A
SYNTAX ERROR
A>10)/A
^
```

```
τ2 4 8
SYNTAX ERROR
τ2 4 8
^
```

```
A.+1 2 3
SYNTAX ERROR
A.+1 2 3
^
```

sys error number

This report is given when an internal error occurs in Dyalog APL.

Under UNIX it may be necessary to enter a hard interrupt to obtain the UNIX command prompt, or even to **kill** your processes from another screen. Under WINDOWS it may be necessary to reboot your PC.

If this error occurs, please submit a fault report to your Dyalog APL distributor.

TIMEOUT

1006

This report is given when the time limit specified by the system variable `⎕RTL` is exceeded while awaiting input through character input (`⎕`) or `⎕SR`.

It is usual for this error to be trapped.

Example

```
⎕RTL←5 ⋄ ⎕←'RESPOND WITHIN 5 SECONDS: ' ⋄ R←⎕
RESPOND WITHIN 5 SECONDS:
TIMEOUT
⎕RTL←5 ⋄ ⎕←'RESPOND WITHIN 5 SECONDS: ' ⋄ R←⎕
      ^
```

TRANSLATION ERROR

92

This report is given when the system cannot convert a character from Unicode to an Atomic Vector index or vice versa. Conversion is controlled by the value of `⎕AVU`. Note that this error can occur when you **reference a variable** whose value has been obtained by reading data from a TCPSocket or by calling an external function. This is because in these cases the conversion to/from `⎕AV` is deferred until the value is used.

TRAP ERROR

84

This report is given when a workspace full condition occurs whilst searching for a definition set for the system variable `⎕TRAP` after a trappable error has occurred. It does not occur when an expression in a `⎕TRAP` definition is being executed.

too many names

This report is given by the function editor when the number of distinct names (other than distinguished names beginning with the symbol `□`) referenced in a defined function exceeds the system limit of 4096.

VALUE ERROR

6

This report is given when either:

- There is no active definition for a name encountered in an expression.
- A function does not return a result in a context where a result is required.

Examples

```

X
VALUE ERROR
X
^

▽ HELLO
[1] 'HI THERE'
[2] ▽

2+HELLO
HI THERE
VALUE ERROR
2+HELLO
^

```

warning duplicate label

This warning message is reported on closing definition mode when one or more labels are duplicated in the body of the defined function. This does not prevent the definition of the function in the active workspace. The value of a duplicated label is the lowest of the line-numbers in which the labels occur.

warning duplicate name

This warning message is reported on closing definition mode when one or more names are duplicated in the header line of the function. This may be perfectly valid. Definition of the function in the active workspace is not prevented. The order in which values are associated with names in the header line is described in *Programming Reference Guide: Defined Functions & Operators*.

warning pendent operation

This report is given on opening and closing definition mode when attempting to edit a pendant function or operator.

Example

```
[0]   ∇FOO
[1]   GOO
[2]   ∇

[0]   ∇GOO
[1]   °
[2]   ∇

      FOO
SYNTAX ERROR
GOO[1] °
      ^

      ∇FOO
warning pendent operation
[0]   ∇FOO
[1]   GOO
[2]   ∇
warning pendent operation
```

warning label name present

This warning message is reported on closing definition mode when one or more label names also occur in the header line of the function. This does not prevent definition of the function in the active workspace. The order in which values are associated with names is described in *Programming Reference Guide: Defined Functions & Operators*.

warning unmatched brackets

This report is given after adding or editing a function line in definition mode when it is found that there is not an opening bracket to match a closing bracket, or vice versa, in an expression. This is a warning message only. The function line will be accepted even though syntactically incorrect.

Example

```
[3]  A[;B[;2]+0
warning unmatched brackets
[4]
```

warning unmatched parentheses

This report is given after adding or editing a function line in definition mode when it is found that there is not an opening parenthesis to match a closing parenthesis, or vice versa, in an expression. This is a warning message only. The function line will be accepted even though syntactically incorrect.

Example

```
[4]  X+(E>2)^E<10)≠A
warning unmatched parentheses
[5]
```

was name

This report is given when the system command `)WSID` is used with a parameter specifying the name of a workspace. The message identifies the former `name` of the workspace. If the workspace was not named, the given report is `CLEAR WS`.

Example

```
)WSID TEMP
was UTILITY
```

WS FULL**1**

This report is given when there is insufficient workspace in which to perform an operation. Workspace available is identified by the system constant `WSA`.

The maximum workspace size allowed is defined by the environment variable `MAXWS`. See *Installation & Configuration Guide: maxws parameter* for details.

Example

```

      WSAp1.2
WS FULL
      WSAp1.2
      ^

```

ws not found

This report is given when a workspace named by the system commands `WSLOAD`, `WSCOPY` or `WPCOPY` does not exist as a file, or when the user does not have read access authorisation for the file.

Examples

```

      WSAp1.2
ws not found

      WSAp1.2
ws not found

```

ws too large

This report is given when:

- the user attempts to `WSLOAD` a workspace that needs a greater work area than the maximum that the user is currently permitted.
- the user attempts to `WSCOPY` or `WPCOPY` from a workspace that would require a greater work area than the user is currently permitted if the workspace were to be loaded.

The maximum work area permitted is set using the environment variable `MAXWS`.

Operating System Error Messages

There follows a numerically sorted list of error messages emanating from a typical operating system and reported through Dyalog APL.

FILE ERROR 1 Not owner

101

This report is given when an attempt is made to modify a file in a way which is forbidden except to the owner or super-user, or in some instances only to a super-user.

FILE ERROR 2 No such file

This report is given when a file (which should exist) does not exist, or when a directory in a path name does not exist.

FILE ERROR 5 I O error

105

This report is given when a physical I/O error occurred whilst reading from or writing to a device, indicating a hardware fault on the device being accessed.

FILE ERROR 6 No such device

This report is given when a device does not exist or the device is addressed beyond its limits. Examples are a tape which has not been mounted or a tape which is being accessed beyond the end of the tape.

FILE ERROR 13 Permission denied

113

This report is given when an attempt is made to access a file in a way forbidden to the account.

FILE ERROR 20 Not a directory

120

This report is given when the request assumes that a directory name is required but the name specifies a file or is not a legal name.

FILE ERROR 21 Is a directory**121**

This report is given when an attempt is made to write into a directory.

FILE ERROR 23 File table overflow**123**

This report is given when the system limit on the number of open files is full and a request is made to open another file. It is necessary to wait until the number of open files is reduced. If this error occurs frequently, the system limit should be increased.

FILE ERROR 24 Too many open

This report is given when the task limit on the number of open files is exceeded. It may occur when an APL session is started or when a shell command is issued to start an external process through the system command `!SH`. It is necessary to reduce the number of open files. It may be necessary to increase the limit on the number of open files to overcome the problem.

FILE ERROR 26 Text file busy**126**

This report is given when an attempt is made to write a file which is a load module currently in use. This situation could occur on assigning a value to an external variable whose associated external file name conflicts with an existing load module's name.

FILE ERROR 27 File too large**127**

This report is given when a write to a file would cause the system limit on file size to be exceeded.

FILE ERROR 28 No space left

This report is given when a write to a file would exceed the capacity of the device containing the file.

FILE ERROR 30 Read only file

This report is given when an attempt is made to write to a device which can only be read from. This would occur with a write-protected tape.

System Errors

Introduction

Dyalog APL will generate a system error and (normally) terminate in one of two circumstances:

- As a result of the failure of a workspace integrity check
- As a result of a System Exception

On Windows, if the **DYALOG_NOPOPUPS** parameter is 0 (the default), it will display the System Error dialog box (see [System Error Dialog Box on page 307](#)). This is suppressed if **DYALOG_NOPOPUPS** is 1.

aplcore file

When a system error occurs, APL normally saves an *aplcore* file which may be sent to Dyalog for diagnosis. The name and location of the *aplcore* file may be specified by the **AplCoreName** parameter. If this parameter is not specified, the *aplcore* file is named `aplcore` and is saved in the current working directory.

Normally a new *aplcore* will replace a file of the same name. However, if **AplCoreName** contains an asterisk (*), the system will create a new file, replacing the asterisk with a number incremented from the largest numbered file present.

The number of *aplcore* files retained by the system is specified by the **MaxAplCores** parameter. If **MaxAplCores** is 0, the system will not save an *aplcore*. However, under Windows, if **DYALOG_NOPOPUPS** is 0, and the user checks the *Create an aplcore file* checkbox when the *System Error* dialog box is displayed, an *aplcore* will be saved regardless of the value of **MaxAplCores**. See [System Error Dialog Box on page 307](#).

Be aware that if your application contains any secure data, this data may be present in an *aplcore* file, and it may be appropriate to set both **MaxAplCores** and **DYALOG_NOPOPUPS** to 0 to prevent such data being saved on disk.

For further information concerning the parameters **AplCoreName**, **DYALOG_NOPOPUPS** and **MaxAplCores**, see *Installation and Configuration Guide*.

Information that may prove useful in debugging the problem, including (where possible) the SI stack at the point where the *aplcore* was generated, is written to the end of *aplcore* files; the section begins with the string

```
'===== Interesting Information'
```

Under UNIX, this interesting information section can be extracted from the *aplcore* as follows:

```
sed -n '/===== Interesting Information/, $p' aplcore
```

Workspace Integrity

When you **)SAVE** your workspace, Dyalog APL first performs a workspace integrity check. If it detects any discrepancy or violation in the internal structure of your workspace, APL does not overwrite your existing workspace on disk. Instead, it displays the System Error dialog box and saves the workspace, together with diagnostic information, in an *aplcore* file before terminating.

A System Error code is displayed in the dialog box and should be reported to Dyalog for diagnosis. This information also appears in the Interesting Information section of the *aplcore* file.

Note that the internal error that caused the discrepancy could have occurred at any time prior to the execution of **)SAVE** and it may not be possible for Dyalog to identify the cause from this *aplcore* file.

If APL is started in debug mode with the **-Dc**, **-Dw** or **-DW** flags, the Workspace Integrity check is performed more frequently, and it is more likely that the resulting *aplcore* file will contain information that will allow the problem to be identified and corrected. It is also possible to enable or alter the debugging level from within APL using the `SetDFlags` method; Dyalog support will direct the use of this feature when necessary.

System Exceptions

Non-specific System Errors are the result of Operating System exceptions that can occur due to a fault in Dyalog APL itself, an error in a Windows or other DLL, or even as a result of a hardware fault. The following system exceptions are separately identified.

Code	Description	Suggested Action
900	A Paging Fault has occurred	As the most likely cause is a temporary network fault, recommended course of action is to restart your program.
990 & 991	An exception has occurred in the Development or Run-Time DLL.	
995	An exception has occurred in a DLL function called via <code>⎕NA</code>	Carefully check your <code>⎕NA</code> statement and the arguments that you have passed to the DLL function
996	An exception has occurred in a DLL function called via a threaded <code>⎕NA</code> call	As above
997	An exception has occurred while processing an incoming OLE call	
999	An exception has been caused by Dyalog APL or by the Operating System	

Recovering Data from *aplcore* files

Objects may often (but not always) be recovered from *aplcore* using `)COPY` or `⎕CY`. Note that if the *aplcore* contains a workspace with more than one instance of the same name on the stack, `⎕CY` copies the most local object whereas `)COPY` copies the global one.

Be aware that in many cases an attempt to `)COPY` from or `)LOAD` an *aplcore* is likely to result in a further syserror; this may result in the original *aplcore* being overwritten, thus losing the contents of that file. It is therefore worth while taking a copy of the *aplcore* before attempting to `)COPY` from it. Attempting to copy specific items is more likely to be successful than copying the entire workspace from the *aplcore*.

Note that in previous versions under Windows because (by default) the *aplcore* file has no extension, it was necessary to explicitly add a dot, or APL would attempt to find the non-existent file `aplcore.dws`. This is no longer true in version 14.1 onwards.

Reporting Errors to Dyalog

If APL crashes and saves an *aplcore* file, please email the following information to support@dyalog.com:

1. a brief description of the circumstances surrounding the error
2. details of your version of Dyalog APL: the full version number, whether it is Unicode or Classic Edition, and the BuildID. This information appears in the *Help->About* box; the *Copy* button copies this information into the clipboard, from where it can be pasted into an email etc.
3. a compressed form of the *aplcore* file itself

If the problem is reproducible, i.e. can be easily repeated, please also send the appropriate description, workspace, and other files required to do so.

System Error Dialog Box

The System Error Dialog illustrated below was produced by deliberately inducing a system exception in the DLL function `memcpy()`. The functions used were:

```

▽ foo
[1]  goo
▽
▽ goo
[1]  hoo
▽
▽ hoo
[1]  crash
▽

▽ crash
[1]  □NA'dyalog64|MEMCPY u u u'
[2]  MEMCPY 255 255 255
▽

```

Note: Under a 32-bit interpreter the `□NA` call should refer to `dyalog32`.

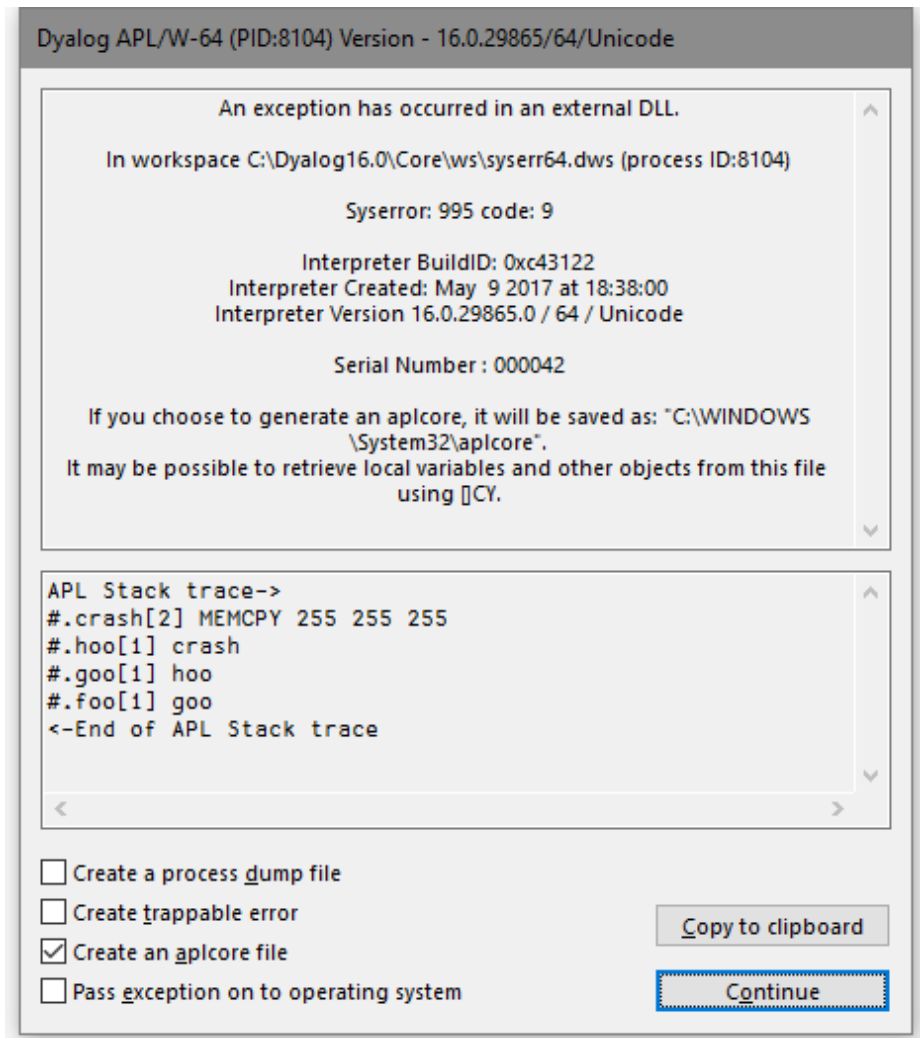

Options

Item	Description
Create a process dump file	Dumps a complete core image, see below.
Create Trappable Error	If you check this box (only enabled on System Error codes 995 and 996), APL will not terminate but will instead generate an error 91 (EXTERNAL DLL EXCEPTION) when you press <i>Dismiss</i> .
Create an aplcore file	If this box is checked, an <i>aplcore</i> file will be created.
Pass exception on to operating system	If this box is checked, the exception will be passed on to your current debugging tool (e.g. <i>Visual Studio</i>). See <i>Installation & Configuration Guide: PassExceptionsToOpSys</i> .
Copy to clipboard	Copies the contents of the APL stack trace window to the Clipboard.

Create a process dump file

Under Windows the *Create a process dump file* option creates a user-mode process dump file, also known as a minidump file, called `dialog.dmp` in the current directory. This file allows post-mortem debugging of a crash in the interpreter or a loaded DLL. It contains much more debug information than a normal *aplcore* (and is much larger than an *aplcore*) and can be sent to Dyalog Limited (zip it first please). Alternatively the file can be loaded into *Visual Studio .NET* to do your own debugging.

Debugging your own DLLs

If you are using Visual Studio, the following procedure should be used to debug your own DLLs when an appropriate Dyalog APL System Error occurs.

Ensure that the *Pass Exception* box is checked, then click on *Dismiss* to close the *System Error* dialog box.

The system exception dialog box appears. Click on *Debug* to start the process in the Visual Studio debugger.

After debugging, the System Exception dialog box appears again. Click on *Don't send* to terminate Windows' exception handling.

ErrorOnExternalException Parameter

This parameter allows you to prevent APL from taking the actions described above when an exception caused by an external DLL occurs. The following example illustrates what happens when the functions above are run, but with the **ErrorOnExternalException** parameter set to 1.

```

    ⎕←2 ⎕NQ'.' 'GetEnvironment' 'ErrorOnExternalException'
1
    foo
EXTERNAL DLL EXCEPTION
crash[2] MEMCPY 255 255 255
    ^
    ⎕EN
91
    )SI
crash[2]*
hoo[1]
goo[1]
foo[1]

```

Note: Dyalog recommends that enabling **ErrorOnExternalException** should only be done while developing or debugging an application; ignoring such errors may result in corruption in the workspace which could result to unexpected errors later in the application.

What should I do if Dyalog hangs?

If Dyalog for Windows hangs, you should generate a process dump file and send it to Dyalog Support, along with your Build ID.

To do this:

1. Start *Task Manager* (as a user who has administrative privileges)
2. Go to the *Processes* tab
3. Right click on the `dyalog.exe` process and choose *Create Dump File*. Windows will create a process dump file in `C:\Users\<your name here>\AppData\Local\Temp\dyalog.DMP`
4. Compress this file and send it to Dyalog. If it is less than 10 Mb in size, send it to Dyalog Support as an email attachment. If it is more than 10 Mb, upload it via the *MyDyalog/My Account* page or contact Dyalog support to request an account on our FTP server.

Symbolic Index

Note that the references in this table refer to entries in the *Language Reference Guide: Contents*.

$+$	See add, conjugate, plus	\geq	See greater or equal
$-$	See minus, negate, subtract	$=$	See equal
\times	See multiply, signum, times	\neq	See not equal
\div	See divide, reciprocal	\equiv	See depth, match
\boxplus	See matrix divide, matrix inverse	\neq	See not match, tally
$ $	See magnitude, residue	\sim	See excluding, not, without
\lceil	See ceiling, maximum	\wedge	See and, caret pointer
\lfloor	See floor, minimum	\vee	See or
$*$	See exponential, power	$\tilde{\wedge}$	See nand
\otimes	See logarithm, natural logarithm	$\tilde{\vee}$	See nor
$<$	See less	\cup	See union, unique
$>$	See greater	\cap	See intersection
\leq	See less or equal	\subset	See enclose, partition, partitioned enclose
		\subseteq	See nest, partition
		\supset	See disclose, mix, pick
		$?$	See deal, roll
		$!$	See binomial, factorial
		\uparrow	See grade up
		\downarrow	See grade down
		\oplus	See execute
		\boxminus	See format
		\perp	See decode
		\top	See encode

┘	See same, left	◦	See compose
└	See same, right	,	See compress, replicate, reduce
○	See circular, pi times	∕	See replicate first, reduce first
⊗	See transpose	\	See expand, scan
⊕	See reverse, rotate	⋈	See expand first, scan first
⊖	See reverse first, rotate first	⋯	See each
,	See catenate, laminare, ravel	⋮	See commute
┌	See catenate first, table	&	See spawn
└	See index generator, index of	✖	See power operator
┘	See where, interval index	⊠	See variant
ρ	See reshape, shape	⊡	See key
ε	See enlist, membership, type	@	See at
⊖	See find	⊠	See stencil
↑	See disclose, mix, take	⊠	See i-beam
↓	See drop, split	⊖	See zilde
←	See assignment	-	See negative sign
→	See abort, branch	-	See underbar character
·	See name separator, decimal point, inner product	Δ	See delta character
◦	See outer product	Δ	See delta- underbar character
⋮	See rank	''	See quotes
		⊠	See index, axis
		[]	See indexing, axis
		()	See parentheses
		{ }	See braces

α	See left argument	<code>:End</code>	See general end control
$\alpha\alpha$	See left operand	<code>:EndClass</code>	See endclass statement
ω	See right argument	<code>:EndFor</code>	See end-for control
$\omega\omega$	See right operand	<code>:EndHold</code>	See end-hold control
<code>#</code>	See Root object	<code>:EndIf</code>	See end-if control
<code>##</code>	See parent object	<code>:EndNamespace</code>	See endnamespace
\diamond	See statement separator	<code>:EndProperty</code>	See endproperty statement
<code>A</code>	See comment symbol	<code>:EndRepeat</code>	See end-repeat control
∇	See function self, del editor	<code>:EndSelect</code>	See end-select control
$\nabla\nabla$	See operator self	<code>:EndTrap</code>	See end-trap control
<code>;</code>	See name separator, array separator	<code>:EndWhile</code>	See end-while control
<code>:</code>	See label colon	<code>:EndWith</code>	See end-with control
<code>:AndIf</code>	See and if condition	<code>:Field</code>	See field statement
<code>:Access</code>	See access statement	<code>:For</code>	See for statement
<code>:Case</code>	See case qualifier	<code>:GoTo</code>	See go-to branch
<code>:CaseList</code>	See caselist qualifier	<code>:Hold</code>	See hold statement
<code>:Class</code>	See class statement	<code>:Include</code>	See include statement
<code>:Continue</code>	See continue branch	<code>:If</code>	See if statement
<code>:Else</code>	See else qualifier	<code>:Implements</code>	See implements statement
<code>:ElseIf</code>	See else-if condition	<code>:In</code>	See in control
		<code>:InEach</code>	See ineach

	control		name
:Interface	See interface statement	□ARBIN	See arbitrary input
:Leave	See leave branch	□ARBOUT	See arbitrary output
:Namespace	See namespace statement	□AT	See attributes
:OrIf	See or-if condition	□AV	See atomic vector
:Property	See property statement	□AVU	See atomic vector - unicode
:Repeat	See repeat statement	□BASE	See base class
:Require	See require statement	□CLASS	See class
:Return	See return branch	□CLEAR	See clear workspace
:Section	See section statement	□CMD	See execute Windows command, start AP
:Select	See select statement	□CR	See canonical representation
:Trap	See trap statement	□CS	See change space
:Until	See until condition	□CSV	See comma separated values
:While	See while statement	□CT	See comparison tolerance
:With	See with statement	□CY	See copy workspace
□	See quote-quad, character I/O	□D	See digits
□	See quad, evaluated I/O	□DCT	See decimal comparison tolerance
□Á	See underscored alphabet	□DF	See display form
□A	See alphabet	□DIV	See division method
□AI	See account information	□DL	See delay
□AN	See account	□DM	See

	diagnostic message		properties
	See dequeue events	□FR	See floating-point representation
□DQ			See file read access matrix
	See data representation	□FRDAC	See file read component information
□DR			See file read component
	See edit object	□FRDCI	See file rename
□ED			See file replace component
	See event message	□FREAD	See file resize
□EM			See file size
	See event number	□FRENAME	See file set access matrix
□EN			See file share tie
	See expunge object	□FREPLACE	See file tie
□EX			See file untie
□EXCEPTION	See exception	□FRESIZE	See fix definition
	See export object	□FSIZE	See instances
□EXPORT			See index origin
	See file append component	□FSTAC	See json convert
□FAPPEND			See key label
	See file available	□FSTIE	See line counter
□FAVAIL			See load workspace
	See file check and repair	□FTIE	See lock definition
□FCHK		□FUNTIE	See latent expression
	See file copy	□FX	
□FCOPY			
	See file create	□INSTANCES	
□FCREATE			
	See file drop component	□IO	
□FDROP			
	See file erase	□JSON	
□FERASE			
	See file hold	□KL	
□FHOLD			
	See file history	□LC	
□FHIST			
	See fix script	□LOAD	
□FIX			
	See file library	□LOCK	
□FLIB			
	See format	□LX	
□FMT			
	See file names		
□FNAMES			
	See file numbers		
□FNUMS			
	See file		
□FPROPS			

<code>MAP</code>	See map file		event
<code>MKDIR</code>	See make directory	<code>NR</code>	See nested representation
<code>ML</code>	See migration level	<code>NREAD</code>	See native file read
<code>MONITOR</code>	See monitor	<code>NRENAME</code>	See native file rename
<code>NA</code>	See name association	<code>NREPLACE</code>	See native file replace
<code>NAPPEND</code>	See native file append	<code>NRESIZE</code>	See native file resize
<code>NC</code>	See name class	<code>NS</code>	See namespace
<code>NCOPY</code>	See native file copy		See namespace indicator
<code>NCREATE</code>	See native file create	<code>NSI</code>	See native file size
<code>NDELETE</code>	See native file delete	<code>NSIZE</code>	See native file tie
<code>NERASE</code>	See native file erase	<code>NTIE</code>	See null item
<code>NEW</code>	See new instance	<code>NULL</code>	See native file untie
<code>NEXISTS</code>	See native file exists	<code>NUNTIE</code>	See native file translate
<code>NGET</code>	See read text file	<code>NXLATE</code>	See sign off APL
<code>NINFO</code>	See native file information	<code>OFF</code>	See variant
<code>NL</code>	See name list	<code>OPT</code>	See object representation
<code>NLOCK</code>	See native file lock	<code>OR</code>	See search path
<code>NMOVE</code>	See native file move	<code>PATH</code>	See program function key
<code>NNAMES</code>	See native file names	<code>PFKEY</code>	See print precision
<code>NNUMS</code>	See native file numbers	<code>PP</code>	See profile application
<code>NPARTS</code>	See file parts	<code>PROFILE</code>	See print width
<code>NPUT</code>	See write text file	<code>PW</code>	See replace
<code>NQ</code>	See enqueue	<code>R</code>	

<code>□REFS</code>	See cross references	<code>□SVO</code>	See shared variable offer
<code>□RL</code>	See random link	<code>□SVQ</code>	See shared variable query
<code>□RSI</code>	See space indicator	<code>□SVR</code>	See shared variable retract
<code>□RTL</code>	See response time limit	<code>□SVS</code>	See shared variable state
<code>□S</code>	See search	<code>□TC</code>	See terminal control
<code>□SAVE</code>	See save workspace	<code>□TCNUMS</code>	See thread child numbers
<code>□SD</code>	See screen dimensions	<code>□TGET</code>	See get tokens
<code>□SE</code>	See session namespace	<code>□THIS</code>	See this space
<code>□SH</code>	See execute shell command, start AP	<code>□TID</code>	See thread identity
<code>□SHADOW</code>	See shadow name	<code>□TKILL</code>	See thread kill
<code>□SI</code>	See state indicator	<code>□TNAME</code>	See thread name
<code>□SIGNAL</code>	See signal event	<code>□TNUMS</code>	See thread numbers
<code>□SIZE</code>	See size of object	<code>□TPOOL</code>	See token pool
<code>□SM</code>	See screen map	<code>□TPUT</code>	See put tokens
<code>□SR</code>	See screen read	<code>□TRACE</code>	See trace control
<code>□SRC</code>	See source	<code>□TRAP</code>	See trap event
<code>□STACK</code>	See state indicator stack	<code>□TREQ</code>	See token requests
<code>□STATE</code>	See state of object	<code>□TS</code>	See time stamp
<code>□STOP</code>	See stop control	<code>□TSYNC</code>	See threads synchronise
<code>□SVC</code>	See shared variable control	<code>□UCS</code>	See unicode convert
		<code>□USING</code>	See using path

<code>□VFI</code>	See verify and fix input	<code>)EVENTS</code>	object
<code>□VR</code>	See vector representation	<code>)FNS</code>	See list events
<code>□WA</code>	See workspace available	<code>)HOLDS</code>	See list functions
<code>□WC</code>	See window create object	<code>)LIB</code>	See held tokens
<code>□WG</code>	See window get property	<code>)LOAD</code>	See workspace library
<code>□WN</code>	See window child names	<code>)METHODS</code>	See load workspace
<code>□WS</code>	See window set property	<code>)NS</code>	See list methods
<code>□WSID</code>	See workspace identification	<code>)OBJECTS</code>	See namespace
<code>□WX</code>	See window expose names	<code>)OBS</code>	See list objects
<code>□XML</code>	See xml convert	<code>)OFF</code>	See list objects
<code>□XSI</code>	See extended state indicator	<code>)OPS</code>	See sign off APL
<code>□XT</code>	See external variable	<code>)PCOPY</code>	See list operators
<code>)CLASSES</code>	See list classes	<code>)PROPS</code>	See protected copy
<code>)CLEAR</code>	See clear workspace	<code>)RESET</code>	See list properties
<code>)CMD</code>	See command	<code>)SAVE</code>	See reset state indicator
<code>)CONTINUE</code>	See continue off	<code>)SH</code>	See save workspace
<code>)COPY</code>	See copy workspace	<code>)SI</code>	See shell command
<code>)CS</code>	See change space	<code>)SINL</code>	See state indicator
<code>)DROP</code>	See drop workspace	<code>)TID</code>	See state indicator name
<code>)ED</code>	See edit object	<code>)VARS</code>	See thread identity
<code>)ERASE</code>	See erase		See global defined

variables
See
)WSID workspace
identity
)XLOAD See quiet-load
workspace

Index

A

access statement 85, 93, 185, 232
 Access Statement 227
 ambivalent functions 19, 78
 and-if condition 90
 APL
 arrays 2
 component files 74
 error messages 278
 expressions 18
 functions 19
 line editor 21, 148
 operators 22
 quotes 4
 statements 79
 APL files 237
 aplcore 304-305
 aplcorename parameter 304
 aplnid parameter 239
 arguments 77
 arguments of functions 19
 array expressions 18
 arrays 2
 boxing user command 13
 depth of 3
 display of 9
 display user command 12
 enclosed 5
 matrix 2
 multi-dimensional 2
 of namespace references 52
 rank of 2
 scalar 2
 shape of 2
 type of 3
 vector 2
 assignment
 distributed 54
 function 21

atomic vector - unicode 296
 atop 26
 attribute statement 86, 93, 226
 auxiliary processors 74

B

bad ws 278
 base class 157, 160, 224
 base constructor 171
 binary integer decimal 38
 binding strength 24
 body
 of function 20
 of operator 23, 77
 boxing user command 13
 braces 20
 branch arrow 113
 branch statements
 branch 113
 continue 114
 goto 113
 leave 113
 return 113

C

callback functions run as threads 60
 cannot create name 278
 canonical representation of operations 77
 case-list qualifier 90
 case qualifier clause 103
 cells 16
 character arrays 4
 characters 4
 circular functions 33
 class statement 224
 classes
 base class 157, 160, 224
 constructors 162-163, 169, 171, 174
 defining 158
 derived from .NET Type 161
 derived from GUI 161
 destructor 169, 176
 editing 159
 fields 179-180, 230
 including namespaces 205

- including script files 222
- inheritance 157, 160
- instances 157, 162, 176
- introduction 157
- members 179
- methods 179, 185
- naming 157
- properties 179, 189, 232
- script 158
- using statement 225

clear ws 278

colon character 81

comments 77, 79

complex numbers 4, 31

- circular functions 33
- floating-point representation 37

component files 74, 238

- access matrix 239
- buffering 252
- file design 249
- internal structure 249
- multi-user access 246
- user number 239

ComponentFile Class example 196

composition operator

- form II 129
- form III 129

conditional statements

- if(condition) 94
- until 99
- while 97

constructors

- base 171
- introduction 163
- monadic 174
- niladic 167, 173
- overloading 164

continue branch statements 114

control qualifiers

- case 103

control structures 90

- disposable 114
- for 101
- hold 106
- if(condition) 94
- repeat 99
- select 103
- trap 110

- while 97
- with 105

control words 101

copy incomplete 278

COPY system command 306

curly brackets 20

D

DEADLOCK 278

decimal comparison tolerance 38

decimal numbers 3

decimal point 3

default constructor 167, 169

default property 195

defined functions 77

defined operations 77

defined operators 77

defining function 20

defining operators 23

definition mode 148

defn error 279

del editor 148

delta-underbar character 6

delta character 6

densely packed decimal 38

depth of arrays 3

derived functions 22, 26, 77

destructor 169, 176

dfns 133

- default left arguments 135
- error guards 138
- guards 136
- lexical name scope 137
- local assignment of 134
- multi-line 134, 147
- recursion 142
- result of 134
- tail calls 142, 146

diamond symbol 79

display user command 12

displaying arrays 9

- boxing user command 13
- display user command 12

displaying assigned functions 21

disposable statement 114

distributed functions 56

- DOMAIN ERROR 280
- dops 133, 141-142
- dyadic functions 19
- dyadic operations 78
- dyadic operators 22
- dyadic primitive functions
 - power 32
- DYALOG_NOPUPS parameter 304
- dynamic localisation 45
- dynamic name scope 137

- E**
- editing directives 151
- else-if condition 90
- else qualifier 90
- empty vectors 4
- enclosed arrays 5
- enclosed elements 5
- end-for control 91
- end-hold control 91
- end-if control 91
- end-repeat control 91
- end-select control 91
- end-trap control 91
- end-while control 91
- end-with control 91
- end control 91
- endproperty statement 232
- endsection statement 114
- EOF INTERRUPT 280
- error guards 138
- error messages 271
- error trapping control structures 110
- ErrorOnExternalException parameter 310
- Euler identity 128
- evaluation of namespace references 44
- exception 280
- expressions 79
 - array expressions 18
 - function expressions 18
- external functions 74
- external variables 73

- F**
- fchk system function 253
- FIELD ... ERROR 281
- field statement 230
- fields 179-180, 230
 - initialising 181
 - private 182
 - public 180
 - shared 183
 - trigger 184
- file access control 239
- FILE ACCESS ERROR 283
- FILE ACCESS ERROR ... 283
- FILE COMPONENT DAMAGED 283
- FILE DAMAGED 284
- FILE FULL 284
- FILE INDEX ERROR 284
- FILE NAME ERROR 284
- FILE NAME QUOTA USED UP 285
- FILE SYSTEM ERROR 285
- FILE SYSTEM NO SPACE 285
- FILE SYSTEM NOT AVAILABLE 285
- FILE SYSTEM TIES USED UP 285
- FILE TIE ERROR 286
- FILE TIE QUOTA USED UP 287
- FILE TIED 286
- FILE TIED REMOTELY 286
- fill item 15
- fix script 158
- floating-point representation 35-36, 38-39
 - complex numbers 37
- for statements 101
- fork 26
- FORMAT ERROR 287
- FORMAT FILE ACCESS ERROR 282
- FORMAT FILE ERROR 282
- FULL-SCREEN ERROR 281
- function assignment 21
- function body 20
- function display 21
- function header 20
- function self-reference 142
- function train 26
- functions 19
 - ambivalent 19, 78
 - arguments of 19
 - defined 77
 - derived 77
 - dfns 133
 - distributed 56

- dyadic 19
- external 74
- left argument 19
- model syntax of 78
- monadic 19
- niladic 19
- right argument 19
- scope of 19

G

- global names 80
- global trigger 87, 120, 229
- goto branch statements 113
- guards 136

H

- hash tables 129
- header
 - of function 20
 - of operator 23, 77
- header lines 80
- high-priority callback 61
- high-priority callback function 109
- high minus symbol 3
- HOLD ERROR 287
- hold statement 109
- hold statements 106
- home namespace 58

I

- idiom 122
- idiom list 122
- idiom recognition 122
- idioms 122
- if statements 94
- implements statement
 - constructor 171
 - destructor 176
 - method 203
 - trigger 117
- in control word 101
- include statement 205
- incorrect command 288

- INDEX ERROR 288
- ineach control word 101-102
- inheritance 157, 160
- initialising fields 181
- instances 162, 176
 - empty arrays of 168-169
- integer numbers 3
- interface statement 223-224
- interfaces 202-203, 224
- INTERNAL ERROR 289
- INTERRUPT 289

K

- KEY CODE RANK ERROR 282
- KEY CODE TYPE ERROR 282
- KEY CODE UNRECOGNISED 282
- keyed property 198, 201
- KeyPress event 282

L

- labels 79-80
- lamp symbol 79
- leave branch statements 113
- left argument of function 19
- left operand of operators 22
- legal names 6
- LENGTH ERROR 290
- levels of migration towards APL2 75
- levels of suspension 131
- lexical name scope 137
- LIMIT ERROR 290
- line editor 148, 151
 - editing directives 151
 - line numbers 152
- line editor, traditional 21
- line labels 79
- line numbers 152
- literals 4
- local names 45, 77, 80, 82
- localisation 80, 82
- locals lines 82
- locking defined operations 130

M

- major cells 16
- mantissae 3
- matrices 2
- methods 179, 185
 - instance 185, 187
 - private 185
 - public 185
 - shared 185-186
 - superseding in the base class 188
- migration levels 75
- monadic functions 19
- monadic operations 78
- monadic operators 22
- multi-dimensional arrays 2

N

- name already exists 291
- name association 61, 67
- name is not a ws 291
- name saved date/time 294
- name scope rules 62
- name separator 77
- namelist 83, 164
- names
 - function headers 78
 - global 80
 - in function headers 83
 - legal 6
 - local 45, 77, 80
- Namespace 40
- namespace does not exist 291
- namespace reference 2, 43, 48
- namespace script 216
- namespace statement 216, 223
- namespaces
 - array expansion 52
 - distributed assignment 54
 - distributed functions 56
 - including in classes 205
 - Introduction 40
 - operators 58
 - reference syntax 42
 - unnamed 50

- negative numbers 3
- negative sign 3
- nested arrays 5
- new instance 162
- niladic constructor 167, 169, 173
- niladic functions 19
- niladic operations 78
- NO PIPES 290
- NONCE ERROR 290
- not copied name 292
- not found name 292
- not saved this ws is name 292
- notation
 - keys 75
 - vector 7
- numbered
 - property 195
- numbered property 194
- numbers 3
 - complex 4
 - decimals 3
 - empty vectors 4
 - integers 3
 - mantissae 3
 - negative 3
- numeric arrays 3

O

- operands 22, 77
- operations
 - model syntax 78
 - pendent 131
 - suspended 131
 - valence of 78
- operators 22
 - body 23
 - derived functions 22
 - dop 141
 - dop self-reference 142
 - dops 133
 - dyadic 22
 - header 23
 - in namespaces 58
 - model syntax of 78
 - monadic 22
 - operands 22

scope of 22
oplocks 285
opportunistic locks 285
or-if condition 90
overridable 185, 188, 227
override 188, 227

P

parallel execution 30
parent object 42
pendent operations 131
Penguin Class example 203
power function 32
PROCESSOR TABLE FULL 293
properties 179, 189
 default 195, 232
 instance 190-191, 232
 keyed 189, 198, 201, 232, 235
 numbered 189, 193-195, 232, 234-235
 private 232
 propertyget function 193
 propertyarguments class 191, 193, 198, 233
 propertyget function 234-235
 propertyset function 193
 propertyshape function 193, 236
 public 232
 shared 192, 232
 simple 189-192, 232, 234-235
property statement 232
propertyarguments class 191, 193, 198, 233
propertyget function 193, 234-235
propertyset function 193
propertyshape function 193
prototype 15

Q

quote character 4

R

RANK ERROR 294
rank of arrays 2
recursion 142

repeat statements 99
require statement 222
RESIZE 294
return branch statements 113
right argument of function 19
right operand of operators 22
Root object 42

S

scalar arrays 2
scalars 2
scope of functions 19
scope of operators 22
search functions 129
search path 157
section statement 114
select statements 103
self-reference
 functions 142
 operators 142
semi-colon separator 77
shape of arrays 2
shy result 14
shy results 78, 136
signal event 319
specification 6
 of variables 6
standard error action 255
state indicator 131
statement separators 79
statements 79
 branch statements 113
 conditional statements 94
static localisation 45
strand notation 7
structuring of arrays 8
subarrays 16
suppressed result 14
suspended operations 131
suspension
 levels of 131
switching threads 61
synchronising threads 68
SYNTAX ERROR 295
syntax of operations 78
sys error number 296

system error codes 306
 system error dialog 304, 307
 system errors 296
 system exceptions 306

T

tail calls 142, 146
 thread switching 61
 threads 59

- debugging 71
- external functions 67
- latch example 70
- paused and suspended 72
- semaphore example 69
- synchronise 68

 threads and external functions 67
 threads and niladic functions 66
 TIMEOUT 296
 tokens

- introduction 68
- latch example 70
- semaphore example 69

 too many names 297
 train 26
 TRANSLATION ERROR 296
 trap control structure 258
 TRAP ERROR 296
 trap statements 110
 trap system variable 260
 trigger fields 184
 triggerarguments class 117
 triggers 117

- global 120

 types of arrays 3

U

underbar character 6
 unnamed namespaces 50
 Unscripted Function 218
 until conditional 99
 user-defined operations 77
 user number 239
 using 157
 using statement 225

V

valence of functions 19
 valence of operations 78
 valency 19
 valid names 6
 VALUE ERROR 297
 variables

- external 73
- specification of 6

 vector arrays 2
 vector notation 7
 vectors 2

- empty numeric 4

 visible names 80

W

warning duplicate label 297
 warning duplicate name 298
 warning label name present in line 0 298
 warning pendent operation 298
 warning unmatched brackets 299
 warning unmatched parentheses 299
 while statements 97
 with statements 105
 workspace integrity check 305
 Workspaces 1
 WS FULL 300
 ws not found 300
 ws too large 300

Z

zilde constant 4

